

**Evaluating CCI Spectrum, Inc. Product for Coating Wastewater Concrete
and Clay Brick Facilities in the City of Houston**

Coating Material

**SPECTRASHIELD LINER SYSTEM
(Dry and Wet Coating)**

Report

Submitted to the

Greater Houston Wastewater Program, City of Houston

By

C. Vipulanandan, H.P Ponnekanti and J. Liu

Center for Innovative Grouting Materials and Technology (CIGMAT)

Department of Civil and Environmental Engineering

University of Houston Houston, Texas 77204-4791

Report No. CIGMAT/UH 96-7

December 1996

TABLE OF CONTENTS

	PAGE NO.
1. ABSTRACT	1
2. INTRODUCTION	2
3. OBJECTIVES	3
4. MATERIALS AND TESTING PROGRAM	4
4.1 Materials	4
4.2 Testing Program	4
(i) Full Scale Test	4
(a) Hydrostatic Test	4
(ii) Laboratory Test	6
(a) Holiday Test - Chemical Resistance	6

	(b) Bonding Strength	8
5.	TEST RESULTS AND DISCUSSION	8
	5.1 Quality Control	8
	5.2 Coating Materials	11
	(a) Full Scale Test	11
	(b) Holiday Test - Chemical Resistance	12
	(c) Bonding Strength	13
6.	CONCLUSIONS	15
7.	REFERENCES	16
	APPENDIX: A. Behavior of Concrete and Clay Brick ..	A.1
	APPENDIX: B. Full Scale Test	B.1
	APPENDIX: C. Holiday Test - Chemical Resistance....	C.1
	APPENDIX: D. Bonding Test	D.1
	APPENDIX: E. Miscellaneous	E.1

INTRODUCTION

Concrete is the most widely used construction material in large wastewater treatment plants. It is commonly used for below grade wet wells or holding tanks; manholes; sewer pipelines and open top channels. Manholes made of clay bricks are also very common. Many municipalities are discovering that particular concrete structures and brick manholes in the wastewater collection and treatment facilities are subjected to corrosive environments and are degrading rapidly. There are several methods in practice to control the degradation of wastewater facilities. (Kienow et al., 1993). The primary goal of rehabilitating these facilities is to return the structure to its original working conditions by in situ methods. Addition of base materials at regular intervals has turned out to be relatively expensive especially when there is regular sewer flooding as the case of sewer facilities in the City of Houston, Texas. Cleaning the pipes regularly by increasing the velocities of flow has not proved to be effective. Coating is one method currently being adopted but the effectiveness of this method for rehabilitating lift stations and sewer treatment facilities is still in question.

Sewer facilities are wet and experience hydrostatic pressure under normal service

conditions. Application of coating materials to such surfaces is considered a challenge and must be evaluated. Bonding between the concrete/clay brick surface and the coating material is another important factor that must be evaluated to determine the performance of the coating. Chemical resistance of coatings to the above mentioned corrosive environment is also very important.

To select the coating systems to solve the concrete corrosion problems, their performance and installation must be well understood. Restoring concrete with coatings requires considering concrete surface conditions (strength and moisture content) and the porosity of the concrete. The minimum recommended surface strength of concrete for using coatings is in the range of 1.4 to 1.75 Mpa (200-300 psi) [Soebbing et al., 1996]. A sufficient quantity of water at the concrete surface can react with the coating material and affect the setting and the adhesion of the coating systems. The surface moisture will depend on the porosity of the concrete and hydrostatic pressure due to the water table. Coatings can debond and blister if the hydrostatic pressure exceeds the tensile adhesion of the coating material. Concrete deterioration can range from slight etching or partial loss of surface cement binder to complete loss of cement binder. Complete binder loss yields exposed coarse aggregates and reinforcing steel which will further accelerate corrosion and cracking and spalling of the concrete. For satisfactory performance, the coating needs to be holiday-free. Many early installations did not ensure holiday-free coating which resulted in premature failure of the coatings.

Coatings can stay in contact with the concrete and protect it from physical/chemical/biological degradation. Durability of a coating material for concrete/clay brick structures is as important as its ability to perform in intended applications. Durability is concerned with life expectancy or endurance characteristics of the coating material. A durable coating is one which will withstand, to a satisfactory degree, the effect of service conditions to which it will be subjected. At present, there is no one coating material that is completely inert to acid attack and physical deterioration. There is only limited information in the literature on the performance of coatings in concrete pipes and the results are not conclusive on the durability of coating materials. Several coating materials were studied by the Los Angeles County and the results show that only a low percentage of coatings performed well under their testing conditions [Redner et al., 1992 and 1994]. Hence, it is important to identify good coating materials for application the Houston area for protecting the structures in the wastewater treatment and collection facilities.

Since several factors in the field can affect the performance of coating, it is important to identify the important factors through controlled experiments where important variables are studied on at a time. In this study, a comprehensive testing program was developed for evaluating SPECTRASHIELD LINER SYSTEM for coating concrete and clay brick facilities.

3. OBJECTIVES

The objective of this study was to evaluate the CCI Spectrum, Inc. Coating material SPECTRASHIELD LINER SYSTEM (4 layers) for various (dry new construction) and wet (rehabilitation) projects in the City of Houston. Specific objectives are as follows: (a) to evaluate the applications and performance of coatings on a concrete surface under hydrostatic pressure of 15psi (32 ft of water); (b) to evaluate the acid resistance of the coated concrete and clay bricks with and without holidays; and (c) to determine the bonding strength of the coating material to concrete and clay bricks over a period of time.

4. MATERIALS AND TESTING PROGRAM

4.1 Materials

Same coating material was used for the dry and wet coating (SPECTRASHIELD LINER) of the

Concrete and clay bricks surfaces. Details on SPECTRASHIELD LINER was provided by the manufacturer and is attached in Appendix E.

SPECTRASHIELD LINER; It is a skin panel system composed of epoxy primer, moisture barrier (modified polymer), surfaces (polyurethane/polymeric blend foam) and final barrier coat (modified polymer) (as per CCI Spectrum, Inc. literature). The system was applied in four-steps and the total thickness was about 1mm (3/4 inch). The epoxy primer was 100% solid. The coating was applied after water jet blasting the surface. The coating was pink in color. Application temperature was 65 degrees Fahrenheit. The coating was applied to the concrete pipe after one month of saturation in the test chamber.

4.2 Testing Program

(1) Full Scale Test

The coatings can be applied to a dry or wet concrete surface. Dry coating condition

simulates the

new concrete surface while the wet condition simulated the rehabilitation condition. The coating applicators were allowed to select the conditions for application of their coating materials.

(a) Hydrostatic Pressure Test: In order to stimulate hydrostatic back pressure on concrete structures due to the water table, it was decided to use concentrically placed concrete pipes to develop the necessary full-scale testing conditions (Fig. L) [Vipulanandan et al., 1996]. This was achieved by using 900 mm inner pipes and 1600 mm outer pipes with two concrete end plates. Steel elements were used to support the entire set-up. Inner concrete pipes were representing a concrete surface under hydrostatic pressure and coating a pipe surface represented most of the difficult conditions encountered in coating structures such as lift stations. The total area available for coating was 14 sq. meter (150 sq. ft.). Based on federal regulations, 900 mm (36in.) diameter pipe was the smallest pipe in which a coating applicator can be allowed to operate within the concrete pipe. Pressure chamber used for the full scale test was designed and built by Gifford-Hill & Company, Houston Division, which was representing the American Concrete Pipe Association.

Dry test (SPECTRASHIELD LINER) Coating was applied to a new 900 mm diameter concrete pipe at the Gifford-Hill & Company concrete pipe yard in Houston. The coated pipe

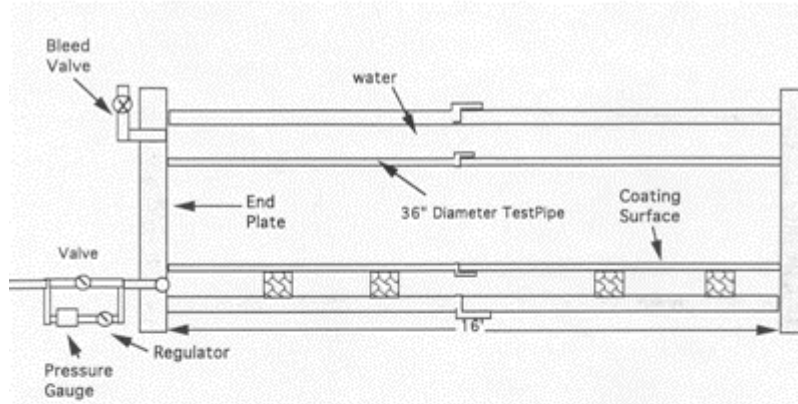

Figure 1. Hydrostatic Pressure Test Chamber Used for Evaluating the Application and Performance of Coatings on Concrete Surface

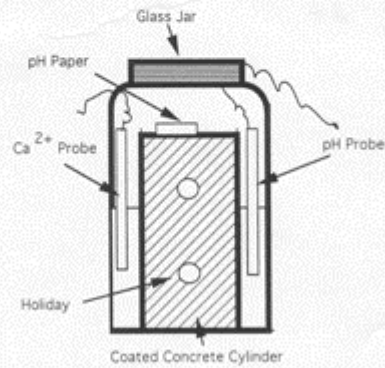

Figure 2. Chemical Test with Holidays for Coated Concrete Specimens (Modified ASTM G 20-88)

was then placed in the pressure chamber for hydrostatic pressure testing.

Wet Test: (SPECTRASHIELD LINER) The 900 mm (36-inch) concrete pipe was installed in the

Test chamber and pressurized at 105kPa (15psi) for at least two weeks before applying the coating.

(B) Measurements

Visual Inspection: The coated surfaces were visually inspected regularly and information the blistering, spalling, discoloring and cracking were noted and photographed. ASTM D 714-87

was used to characterize the blister size and frequency and will be designated as dense, medium dense, medium or few accordingly.

Bonding Test (ASTM D 4541-85): In situ bonding tests on the coating materials were performed at the end of the hydrostatic test. A 51 mm (2 in.) diameter core drill was used to core into the concrete surface and isolate the test area and a metal piece was glued to the coating with an epoxy. After 24 hrs of curing, the test was performed using a hydraulic loading system to determine the bonding strength and the type of failure.

(ii) Laboratory Test

(a) Holiday Test – Chemical Resistance (Modified ASTM G 20-88)

In order to study the chemical resistance ASTM G 20-88 test was modified to use with concrete

and clay brick materials. As shown in Fig. 2 the specimens are immersed in a selected test reagent to half the specimen height in a closed bottle so that the specimens are exposed to the liquid phase and vapor phase. This method is intended for use as a relatively rapid test to evaluate the acidic resistance of coated specimens under anticipated service conditions. In this test, 76 mm (3-inch) X 152 mm (6-inch) cylindrical cement concrete specimens were used. Specimens were prepared by stripping the molds from the concrete cylinders leaving the base in place. Clay bricks were cut to a size of 50 mm (2 inch) X 38 mm (1.5 inch) X 152 mm (6-inch) for this test. Dry and wet specimens were coated on all sides except the base (only for concrete) and tested. For the test two radial holes were drilled into the specimen approximately 15 mm deep (Fig. 3). In this test the changes in (1) amount of calcium leached into the in test medium (2) weight of specimen (3) appearance of specimen and (4) pulse velocity (ASTM C 597-83) of the specimen were measured at regular intervals. The three reagents selected for this study are (1) deionized (DI) water (pH= 5 to 6) (2) 3% sulfuric acid solution (pH = 0.45; representing the worst reported condition in the wastewater system) and (3) 30% sulfuric acid solution (pH = - 0.8; representing accelerated testing conditions) were selected for testing the coated materials. Control tests were performed with no holidays. Over 30 specimens were tested for each coating material.

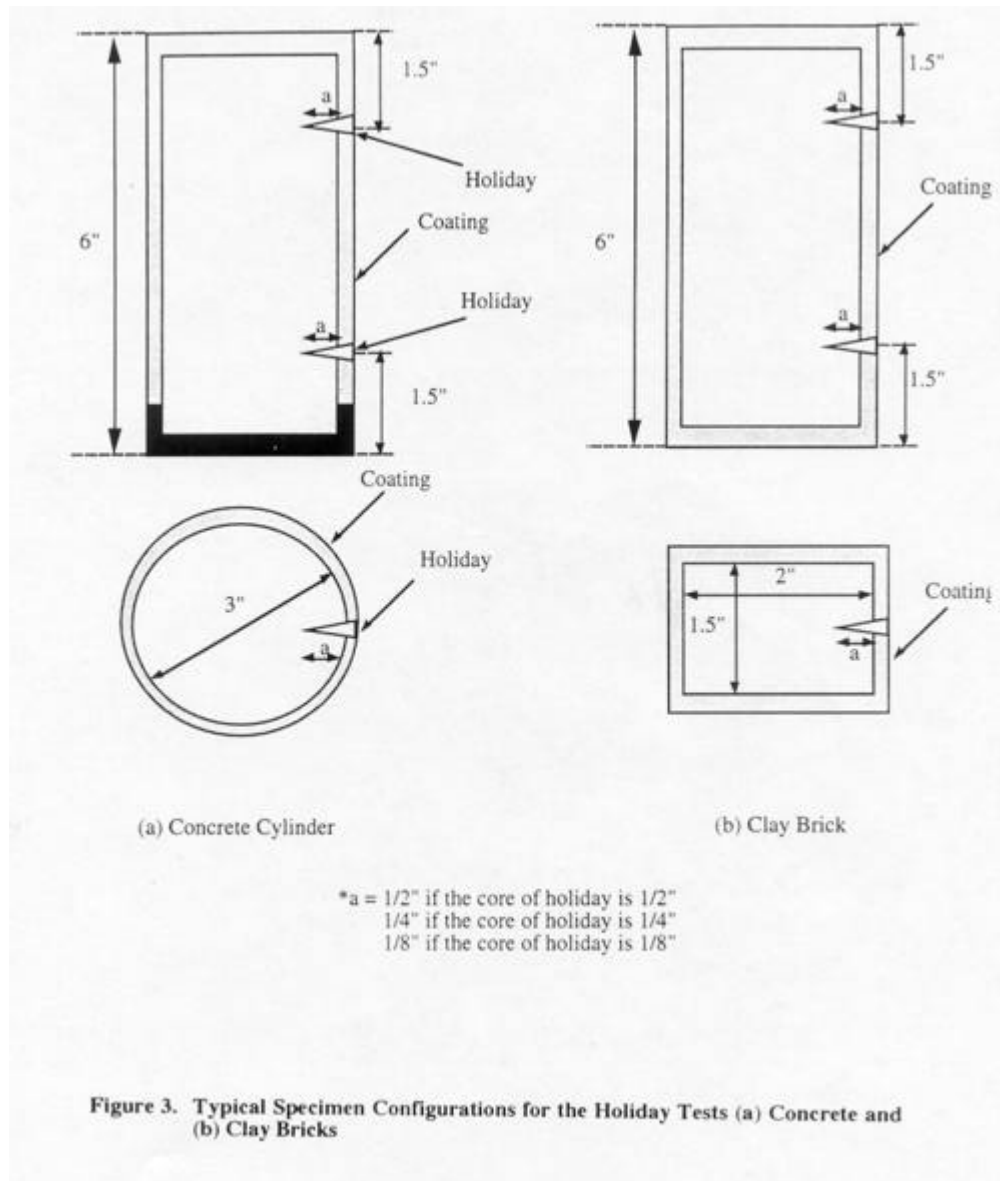

(b) Bonding Strength

These test were performed to determine the bonding strength (pull-off strength) between

The concrete/clay brick and the coating material over a period of one year.

ASTM C 321-94: In this test the coating was sandwiched between a pair of rectangular concrete

block and clay brick specimens and then tested for bonding strength (Fig 4 (a)). Both dry and wet specimens were used to simulate the extreme coating conditions. The bonded specimens were cured under water up to the point of testing. Total of twelve tests were performed during the period covered in this report.

ASTM D 4541-85: In this test 51mm (2-in) diameter circular area was used for testing (Fig 4 (b)). Coated concrete blocks and clay bricks were cored using a diamond core drill to predetermined depth to isolate the coating and a metal fixture was glued to the isolated coating section using a rapid setting epoxy. Total of twelve tests were performed during the period covered in this report.

5 TEST RESULTS AND DISCUSSION

Concrete cylinders, blocks and clay bricks were first evaluated to quantify their quality and acid

resistance. All the test specimens for the laboratory tests were prepared at the University of Houston Test Site over a period of two days.

5.1 Quality Control

To ensure the quality of the concrete and clay bricks specimens used in the coating studies the unit

weight and pulse velocity of the specimens were measured. More details are in Appendix A.

(i) Unit Weight and Pulse Velocity

To ensure the quality of the concrete and brick specimens used in the coating studies the

Unit weight and pulse velocity of the specimens were measured.

Concrete: The variation of pulse velocity with unit weight is shown in Fig. A1. The unit weight of concrete specimens varied between 22.5 kN/m³ (142 pcf) and 25.5 kN/m³

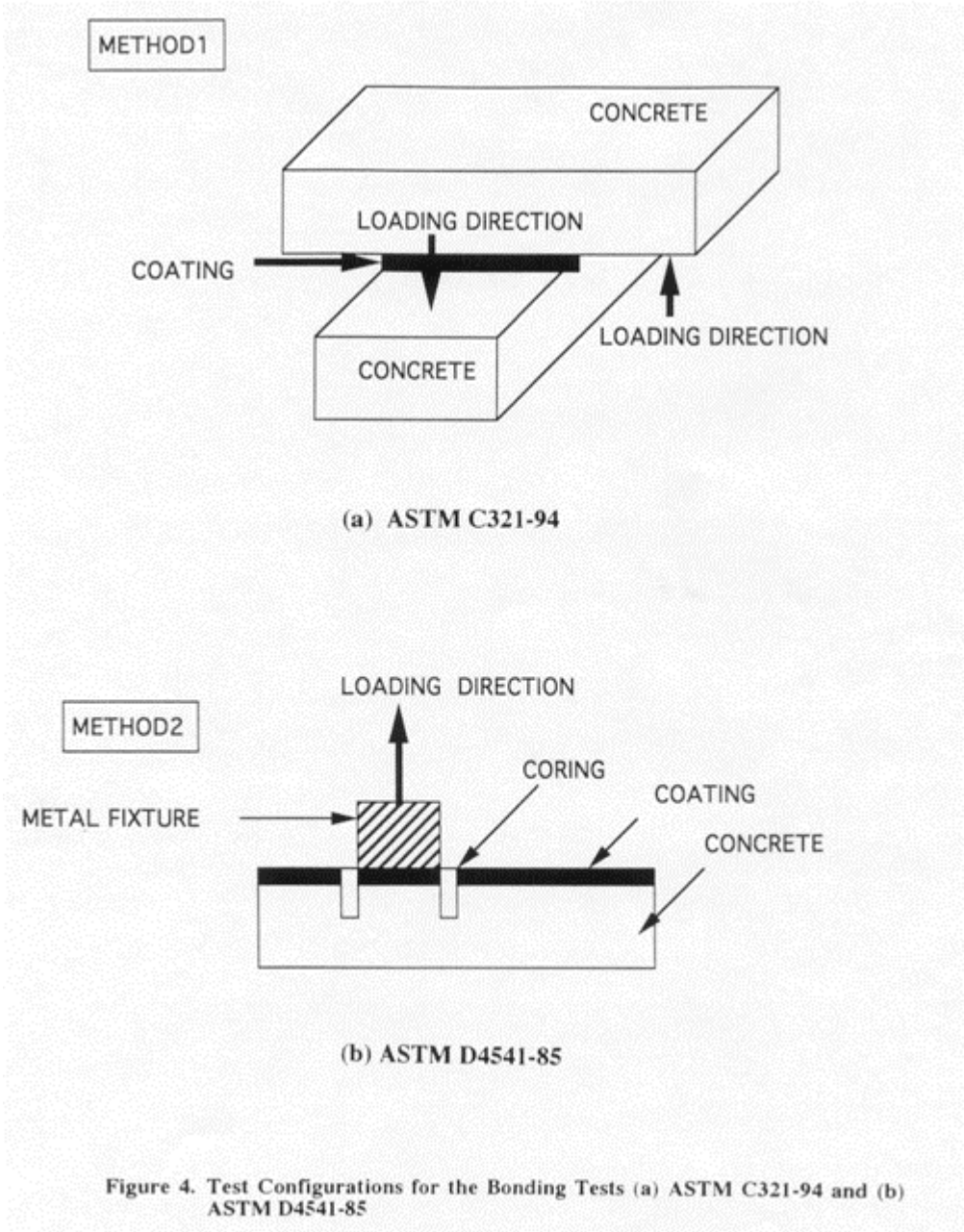

(158 pcf). The variation of pulse velocity with the unit weight could be considered negligible (Fig. A1 (a)). The pulse velocity results showed a normal distribution with a mean value of 4748 m/s (15,576 ft/s) and a coefficient of variation (cov) of 2%.

Clay Brick: The variation of pulse velocity with unit weight is shown in Fig. A2. The pulse velocity results showed a normal distribution with a mean value of 2552m/s (8,372 ft/s) and a coefficient of variation (cov) of 3%. The unit weight of clay brick specimens varied between 19.0 kN/m³ (122 pcf) and 22.1 kN/m³ (138 pcf).

(ii) **Chemical Resistance**

Concrete: Results are summarized in Tables A1 and A2 for concrete cylinders dry and wet respectively. Dry concrete cylinder partially submerged (50%) in water showed an increase in weight of 0.4% in the initial thirty days due to infiltration and showed further increase up to sixty days. Acid solutions attacked the concrete resulting in weight loss within the first ten days of exposure. With further exposure there was increased chemical reaction (visible due to changes in color of concrete from gray to white) and spalling of material from the specimen surface. Weight loss continued up to 60 days as summarized in Tables A1 and A2. After 60 days of exposure to 3% sulfuric acid solution the concrete specimens showed a few percent loss in weight and the surface appeared to be similar to some of the worst corroded concrete sewer facilities (Fig. A3). No visible corrosion was observed above the liquid phase (vapor phase) in the concrete specimen in 3% sulfuric acid (pH = 0.45). Substantial difference in performance was observed between dry and wet concrete in 30% sulfuric acid. Dry concrete in 30% sulfuric acid showed acid attack not only in the concrete submerged in the liquid phase but also corrosion in the portion of concrete in the vapor phase due to capillary action and diffusion of the strong acid. Concrete cylinder continued to loose weight due to chemical reaction and spalling of reacted materials and aggregates forming an hour glass shape specimen (Fig. A3). Dry and wet concrete could be assumed to have failed in ten and thirty days respectively in 30% sulfuric acid solution.

Clay Bricks: Results are summarized in Tables A3 and A4 for dry and wet clay brick respectively. Dry bricks in water and acids showed similar gain in weight of over 20% . No visible damage in bricks were observed. Wet bricks showed much smaller weight gain as compared to the dry bricks. In the case of wet bricks, 30% sulfuric acid showed the greatest gain in weight of over 3.5% in 60 days of testing. Weight increase was not observed with further soaking.

(iii) **Strength**

Concrete: Compressive and flexural strength of dry and wet concrete are summarized in Table A5 in Appendix A. The average compressive strength of 28 days water cured concrete was 34 MPa (5000psi) and the flexural strength was 8.3 Mpa (1200 psi). While the compressive strength was sensitive to the dry and wet curing conditions the flexural strength was not. Data

for tensile strength of concrete was obtained from Type 1 failure in the ASTM D4541-85 tests. psi (3.5 Mpa) (Varied from 353 to 550 10% of the compressive strength and 42% of the flexural strength.

Clay Brick Flexural and tensile strength of dry and wet clay bricks are summarized in Table A5 in Appendix A. The average flexural strength was 7.0 psi). Average direct tensile strength of clay brick was 420 Mpa) (varied from 369 to 468 the flexural strength. While the flexural strength is important for bonding test ASTM C321-94, tensile strength is important for the ASTM D4541-85 bonding test.

(a)

In order to evaluate the potential of applying the coating SPECTRASHIELD LINER on dry

surface (simulating new construction or above water table application) and wet surface (under a hydrostatic water back pressure of 15 performed. Performance of coated surfaces was evaluated over a period of five months (December 1, 1995 to May 3, 1996).

Coating was applied successfully under dry and wet (hydrostatic test) conditions respectively. Dry coating was done at the coating manufacturers' site in Florida and transported back to the test site at UH. Wet coating was applied with ease in for steps at the University of Houston testing site (Dec. 1, 1995). Coatings were inspected during and immediately after application. No immediate defects (blistering, cracking, discoloration, spalling, sticking to the finger after 48 hours of application, scratch-off) were observed on the dry coated surfaces. Except for very small area of fine hard blisters (Table B3, caused by excess polymer) no other defect was observed in the wet coating.

Rating:

(i) Dry coating (SPECTRASHIELD LINER) passed* the application test.

Coverage of the concrete surface was good.

- (ii) Wet coating (SPECTRASHIELD LINER) passed* the application test.

Coverage** of the concrete surface was good.

*Passing means (1) no blistering, (2) no cracking, (3) no discoloration, (4) no spalling, (5) not stick to the finger after 48 hours of application and (6) cannot scratch off.

**Coverage rating was selected from good, satisfactory or bad. Good rating means no visible spot of concrete surface; Satisfactory rating means a few small spots of visible concrete surface; Bad rating means several spots of visible concrete surface.

Performance

The coatings were tested under a hydrostatic pressure of 105 kPa (15 psi) over a period of five months. For inspection purposes each eight feet length of 900 mm (36 in.) pipe was divided into 12 (4 X 3) sections of approximate area of 900 sq. in. (6.3 sq. ft.) each. The coatings were inspected on a regular basis to identify any visible defects and mapped on 4 X 3 format as shown in Table B1. Table B1 summaries the performance of coating SPECTRASHIELD LINER (Dry) in each section of the pipe. In Fig. B1 photographs of the center strip is shown. Each section was evaluated for (I) overall condition (ii) surface texture (iii) blistering (iv) cracking (v) change in color and (vi) quality of finish. In all of these categories the two coatings performed well. The performance of the SPECTRASHIELD LINER (Wet) is summarized in Tables B2 and B3 with a photograph in Fig. B2.

Overall Rating:

- (i) Dry coating (SPECTRASHIELD LINER) passed the performance test in all categories ((I) through (vi))
- (ii) Wet coating (SPECTRASHIELD LINER) passed the performance test in all categories ((I) through (vi))

(b) Holiday Test – Chemical Resistance

In order to evaluate the performance of SPECTRASHIELD LINER (dry and wet) coatings, coated

concrete cylinders and clay bricks were tested with and without holidays in water, 3% sulfuric acid and 30% sulfuric acid solutions. Performance of both coatings were evaluated over a period of six months from December 1, 1995 to June 1, 1996 in this report. Total of 32 concrete and 27 clay brick coated specimens were tested. All specimens passed the vapor phase test and liquid phase results are summarized in Tables C1 through C8. The tests are being continued on the passing specimens and City of Houston will be updated on the test results.

SPECTRASHIELD LINER (Dry Coating)

Concrete

One month: All specimens passed the test.

Six months: All specimens with and without holiday passed the test. Specimens in 30% sulfuric acid changed color from original ping to dark brown.

Clay Brick

One Month: All specimens passed the test.

Six Months: All specimens passed the test. Specimens in 30% sulfuric acid had color changes.

(c) Bonding Strength

Bonding strengths of SPECTRASHIELD LINER (Dry and Wet) coatings with concrete

and clay

brick were determined according to ASTM D4541-85 and ASTM C321-94 testing methods over a period of twelve and nine months respectively. All the specimens were cured under water. Both dry and wet specimens were coated to simulate the Full-scale testing conditions. Performance of both coating were evaluated starting December 1, 1995 and the results are included in this report. Of the 26 bonding tests, 14 test were with concrete and 12 with clay brick. Two in situ bonding tests were done on the coated pipes with the hydrostatic pressure still on. The results are summarized in Table D1 through D8 with the type of failure. Several more tests are planned and City of Houston will be updated on the test results.

SPECTRASHIELD LINER (Dry Coating)

Concrete

ASTM D4541-85: All the failures were Type 2 where the coating failed in direct tension. Average coating strength from laboratory test was less than 61psi (0.4 MPa)(Table D1). In situ bonding strength was 71 psi (0.5 MPa) and the failure was in the coating (Type 2).

ASTM C321-94 (With Primer Only): All failures were Type 1 where the concrete block failed in bending. The bonding strength did not change much with time. Average bonding strength from laboratory tests were greater than 225 psi (1.6 MPa) (Table D5).

Summary: All coating (four layers) failures from ASTM D4541-85 test were Type 2. All primer failures from ASTM C321-94 test were Type 1. The average coating strength from ASTM D4541-85 was 61 psi (0.4 MPa). The bonding strength of primer from ASTM C321-94 test was greater than 225 psi (1.6MPa). In situ coating strength was 71 psi (0.5MPa) and the coating failed (Type 2). Bonding strength of primer with dry concrete was good. Poor coating (4 layer system) strength.

Clay Brick

ASTM D4541-85: All the failures were Type 2 where the coating failed in direct tension (Table D3). Coating strength varied from 60 to 180 psi.

ASTM C321-94 (With Primer Only): All the failures were Type 1 indicating good bonding strength with the primer. The bonding strength varied from 265 to 317 psi with an average

strength of 283 psi (2.0 MPa) (Table D7).

Summary: All coating (four layers) failures from ASTM D4541-85 test were Type 2. All primer failures from ASTM C321-94 tests were Type 1. The bonding strength of primer from ASTM C321-94 test was greater than 283 psi (2.0 MPa). Bonding strength of primer with dry clay brick was good. Poor coating (4 layer system) strength.

SPECTRASHIELD LINER (Wet Coating)

Concrete

ASTM D4541-85: All the failures were Type 2 where the coating failed in direct tension. Average coating strength from laboratory tests was 51 psi (0.35 MPa) (Table D2).

ASTM C321-94 (With Primer Only): All failures were Type 1. The bonding strength did not change much with curing time. Average bonding strength from laboratory test was greater than 223 psi (1.5 MPa) (Table D6).

Summary: All coating (four layers) failures from ASTM D4541-85 test were Type 2. All primer failures from ASTM C321-94 test were Type 1. The average coating strength from ASTM D4541-85 was 51 psi (1.5 MPa). The bonding strength of primer from ASTM C321-94 test was greater than 223 psi (1.5 MPa). Bonding strength of primer with wet concrete was good. Poor coating (4 layer system) strength.

Clay Brick

ASTM D 4541-85: All the failures were Type 2 where the coating failed in direct tension. The coating strength varied from 24 to 95 psi with an average of 59 psi (0.4 MPa) (Table D4).

ASTM C321-94 (With primer only): All failures were Type 1. The bonding strength varied from 249 to 358 psi with an average of 289 psi (2.0 MPa) (Table D8).

Summary: All coating (four layers) failures from ASTM D4541 test were Type 2. All primer failures from ASTM C321-94 test were Type 1. The average coating strength from ASTM

D4541-85 was 59 psi (0.4 MPa). The bonding strength of primer from ASTM C321-94 test was greater than 289 psi (2.0 MPa). Bonding strength of primer with wet clay brick was good. Poor coating (4 layer system) strength.

6. CONCLUSIONS

A combination of full-scale and laboratory test were used to evaluate the performance of SPECTRASHIELD LINER (dry and wet) for coating concrete and clay bricks. Based on the test results following observations are advanced.

- (1) Coating passed the dry and wet application (seven evaluation categories) and performance (six evaluation categories) tests.
- (2) All coated concrete (dry and wet) with and without holidays passed the holiday-chemical Resistance tests in 3% and 30% sulfuric acid solutions after six months.
- (3) All coated clay bricks (dry and wet) with and without holidays passed the chemical resistance test after six months (reporting time).
- (4) Primer had good bonding strength with the dry and wet concrete and clay brick. Coating (4 layers) had poor coating strength and hence the failures were within the coating in all the cases investigated.

7. REFERENCES

- [1] Annual Book of ASTM Standards (1995), Vol. 06.01, Paints-Tests for Formulated Products and Applied Coatings, ASTM, Philadelphia, PA.

- [2] Annual Book of ASTM Standards (1995), Vol. 04.05, Chemical Resistant Materials; Vitriified Clay, Concrete, Fiber-Cement Products; Mortar; Masonry, ASTM, Philadelphia, PA.
- [3] EPA (1974), "Sulfide Control in Sanitary Sewerage System", EPA 625/1-74-005. Cincinnati, Ohio.
- [4] EPA (1985), "Odor and Corrosion Control in Sanitary Sewerage System and Treatment Plants", EPA 625/1-85/018, Cincinnati, Ohio.
- [5] Kienow, K. and Cecil Allen, H. (1993). "Concrete Pipe for Sanitary Sewers Corrosion Protection Update," Proceedings, Pipeline Infrastructure II, ASCE, pp. 229-250.
- [6] Redner, J. A., Randolph P. Hsi, and Edward Esfandi (1992), "Evaluation of Protective Coatings for Concrete" County Sanitation District of Los Angeles County, Whittier, CA.
- [7] Redner, J. A., Randolph, P. Hsi, and Edward Esfandi (1994), "Evaluating Coatings for Concrete
in Wastewater facilities: Update," Journal of Protective Coatings and Linings,
December 1994,
pp 50-61.
- [8] Soebbing, J. B., Skabo, Michel, H. E., Guthikonda, G. and Sharaf, A.H. (1996),
"Rehabilitating
Water and Wastewater Treatment Plants," Journal of Protective Coatings and Linings,
May 1996, pp. 54-64.
- [9] Vipulanandan, C., Ponnekanti, H., Umrigar, D. N., and Kidder, A. D. (1996), "Evaluating

Coatings for Concrete Wastewater facilities.” Proceedings, Fourth Materials Congress, American Society of Civil Engineers, Washington D.C., November 1996, pp. 851-862.

CCI Spectrum, Inc.’s Response to Conclusion (4)

The “Pull Test” was designed for a monolithic coating (one layer). The test was not modified to accommodate a multi-layer system. SPECTRASHIELD is a multi-layered system. Delamination of the layers occurred to the foam layer. The SPECTRASHIELD lining system was not designed to and would not encounter such a force when installed in a structure.

APPENDIX A

Behavior of Cement Concrete and Clay Brick

Summary

In order to ensure the quality of the concrete cylinders and blocks, and clay bricks used in this study the materials were tested on a regular basis and the results are summarized in this section.

A. 1. Unit Weight and Pulse Velocity

To ensure the quality of the concrete and brick specimens used in the coating studies the unit weight and pulse velocity of the specimens were measured.

Concrete: The variation of pulse velocity with unit weight is shown in Fig. A1. The unit weight

of concrete specimens varied between 22.5 kN/m³ (142 pcf) and 25.5 kN/m³ (158 pcf). The variation of pulse velocity with the unit weight could be considered negligible (Fig. A1 (a)). The pulse velocity results showed a normal distribution with a mean value of 4748 m/s (15,576ft/s) and a coefficient of variation (cov) of 2%.

Clay Brick:

The variation of pulse velocity with unit weight is shown in Fig. A2. The pulse velocity results showed a normal distribution with a mean value of 2552 m/s (8,372 ft/s) and a coefficient of variation (cov) of 3%. The unit weight of clay brick specimens varied between 19.0 kN/m³ (120 pcf) and 22.1 kN/m³ (138 pcf).

A. 2. Chemical Resistance

Concrete: Results are summarized in Tables A1 and A2 for concrete cylinders dry and wet respectively. Dry concrete cylinder partially submerged (50%) in water showed an increase in weight of 0.4% in the initial thirty days due to infiltration and showed further increase up to sixty days. Acid solutions attacked the concrete resulting in weight loss within the first ten days of exposure. With further exposure there was increased chemical reaction (visible due to changes in color of concrete from gray to white) and spalling of material from the specimen surface. Weight loss continued up to 60 days as summarized in Tables A1 and A2. After 60 days of exposure to 3% sulfuric acid solution the concrete specimens showed a few percent loss in weight and the surface appeared to be similar to some of the worst corroded concrete sewer facilities (Fig. A3). No visible corrosion was observed above the liquid phase in the concrete specimen in 3% sulfuric acid (pH= 0.45). Substantial difference in performance was observed between dry and wet concrete in 30% sulfuric acid. Dry concrete in 30% sulfuric acid showed acid attack not only in the concrete submerged in the liquid phase but also corrosion in the portion of concrete in the vapor phase due to capillary action and diffusion of the strong acid. Concrete cylinder continued to lose weight due to chemical reaction and spalling of reacted materials and aggregates forming an hour glass shape specimen (Fig. A3). Concrete cylinder totally collapsed under its own weight within 90 days. Dry and wet concretes could be assumed to have failed in ten and thirty days respectively in 30% sulfuric acid solution.

Clay Bricks: Results are summarized in Tables A3 and A4 for dry and wet clay brick respectively. Dry bricks in water and acids showed similar gain in weight of over 20%. No visible damage in bricks were observed. Wet bricks showed much smaller weight gain as compared to the dry bricks. In the case of wet bricks, 30% sulfuric acid showed the greatest gain of weight of over 3.5% in 60 days of testing. Weight increase was not observed with further soaking.

A. 3. Strength

Concrete: Compressive and flexural strength of dry and wet concrete are summarized in Table A5 in Appendix A. The average compressive strength of 28 days water cured concrete was 34 MPa (5000 psi) and flexural strength was 8.3 MPa (1200 psi). While the compressive strength was sensitive to the dry and wet curing conditions the flexural strength was not. Data for tensile strength of concrete was obtained from Type 1 failure in the ASTM D4541-85 tests. Average tensile strength of concrete was 460 psi (3.2 MPa) (Varied from 353 to 550 psi) about 9.5% of the compressive strength and 39% of the flexural strength.

Clay Brick: Flexural and tensile strength of dry and wet clay bricks are summarized in Table A5 in Appendix A. The average flexural strength was 7.0 MPa (1000 psi). Average direct of tensile strength of clay brick was 420 psi (2.9 MPa) (varied from 369 to 468 psi) about 42% of the flexural strength. While the flexural strength is important for bonding test ASTM C321-94, tensile strength is important for the ASTM D4541-85 bonding test.

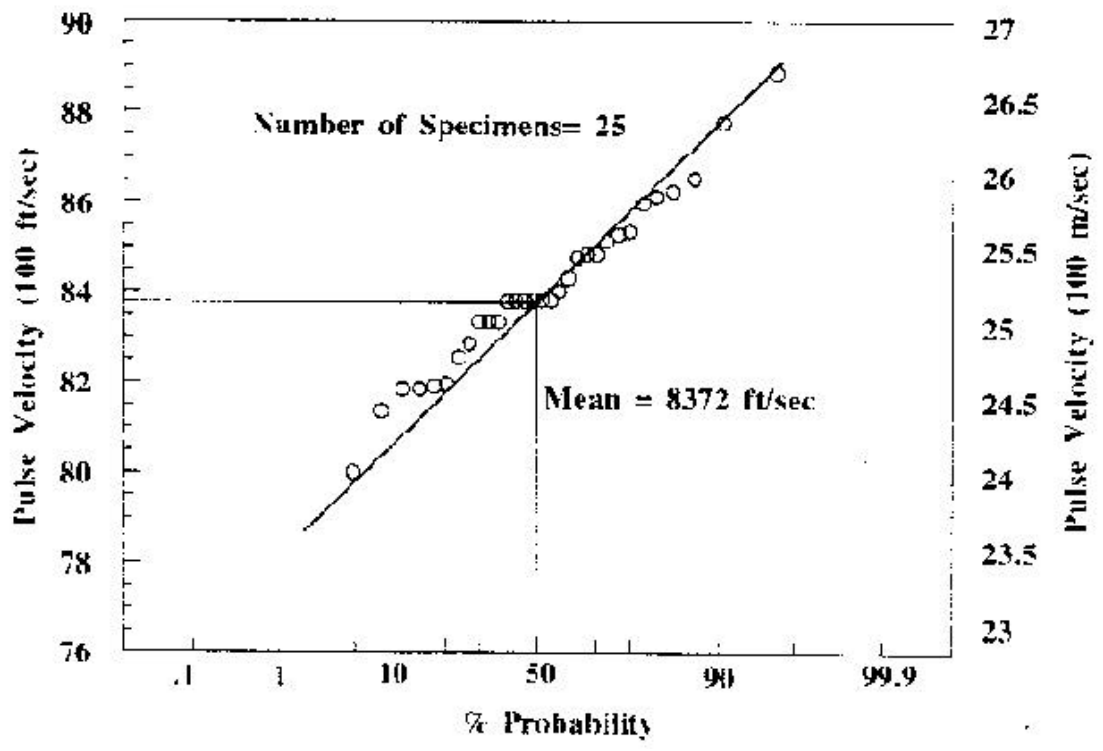
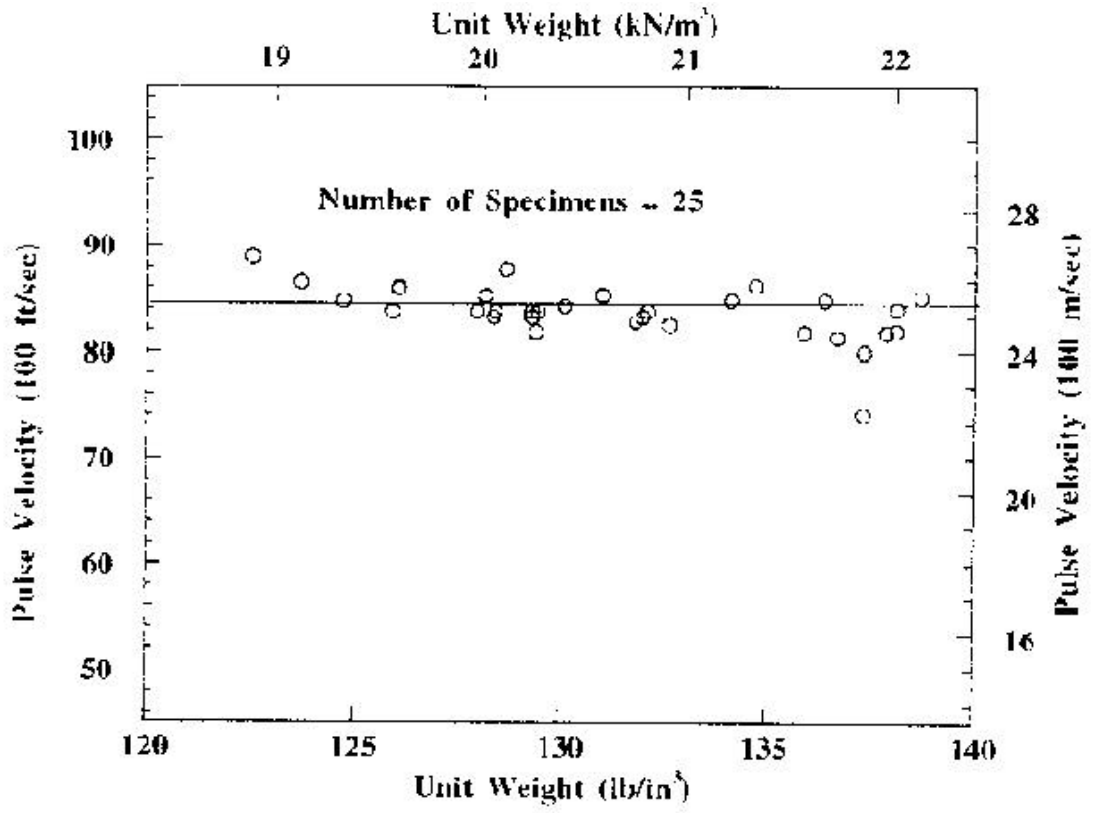

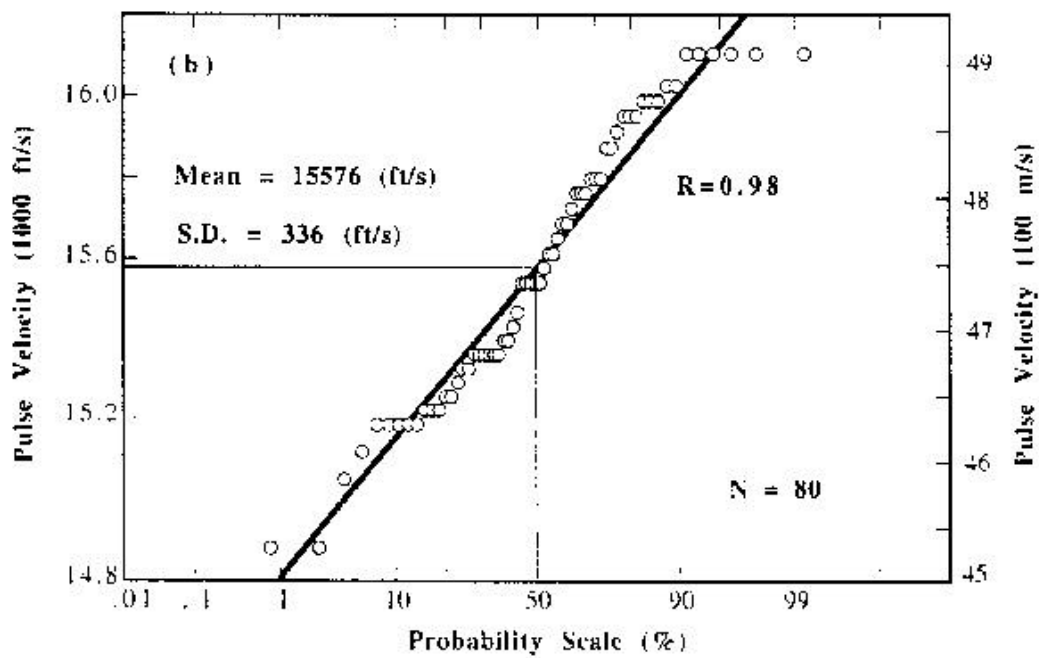
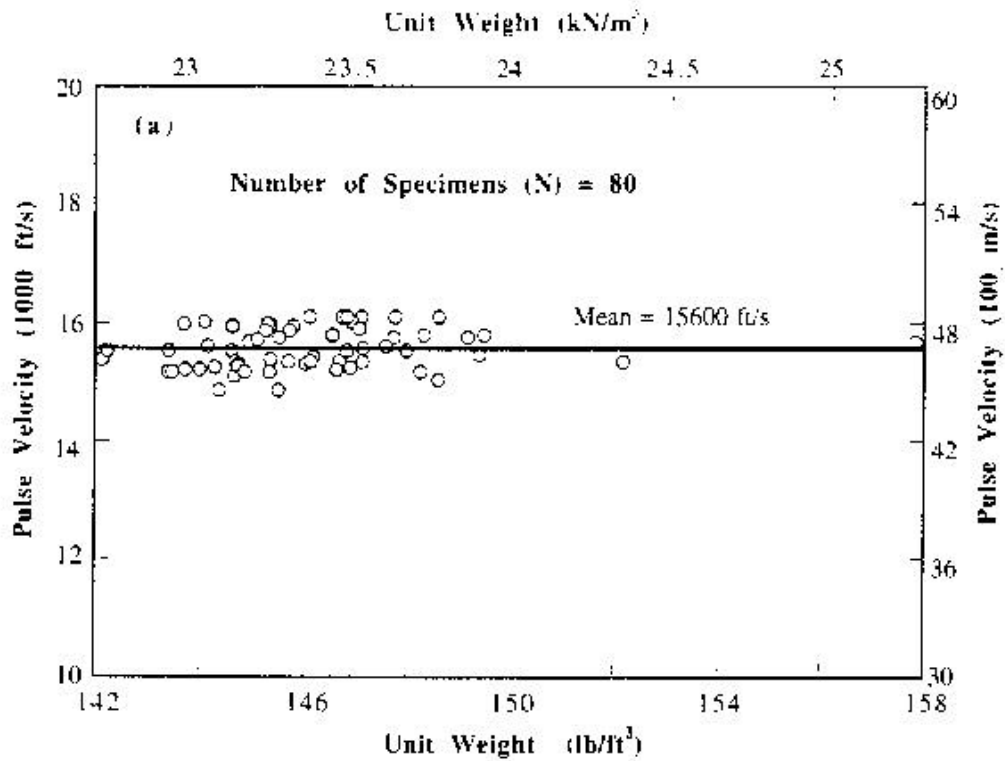

Concrete	Immersion Time (days)	Medium and Weight Change(%)			Remarks
		DI Water	3% H ₂ SO ₄	30% H ₂ SO ₄	
Dry	10	0.25	-0.30	-3.50	Sever corrosion with 30% acid
	30	0.40	-0.60	-11.00	Visible corrosion in 3% acid
	60	0.60	-1.10	-22.00	Corrosion continues in acid
Remarks	Up to 60 days of immersion	Weight gained. Infiltration	Weight loss. Sever corrosion in the liquid phase	Weight loss. Collapsed in 60 days. Excessive corrosion.	30% acid is extremely corrosive. May be used in accelerated tests

*50% of specimen was submerged in liquid.

Table A2. Results from Chemical Attack Test* on Wet Concrete (Modified ASTM G20-88; No Holiday)

Concrete	Immersion Time (days)	Medium and Weight Change(%)			Remarks
		DI Water	3% H ₂ SO ₄	30% H ₂ SO ₄	
Wet	10	0.025	0.40	-2.40	Notable corrosion with 30% acid
	30	0.03	-1.00	-3.00	Visible corrosion in 3% acid
	60	0.10	-1.70	-4.00	Corrosion continues in acid
Remarks	Up to 60 days of testing	Weight gained. Infiltration	Weight loss. Sever corrosion in the liquid phase	Weight loss. Excessive corrosion in the liquid phase.	30% acid is extremely corrosive. May be used in accelerated tests. Overall corrosion is much less than dry concrete

Table A3. Results from Chemical Attack Test* on Dry Clay Brick
(Modified ASTM G20-88; No Holidays)

Concrete	Immersion Time (days)	Medium and Weight Change(%)			Remarks
		DI Water	3% H ₂ SO ₄	30% H ₂ SO ₄	
Dry	10	11.0	10.0	13.0	Similar increase in weight
	30	17.0	16.0	20.0	Similar increase in weight
	60	20.0	22.0	24.0	Acids are slightly higher
Remarks	Up to 60 days of testing	Weighted gained. Infiltration	Weight gained. Infiltration. No visible damage	Weight gained. Infiltration. No visible damage	More than 20% increase in weight. No visible damage.

*50% of specimen was submerged in liquid.

Table A4. Results from Chemical Attack Test* on Wet Clay Brick
(Modified ASTM G20-88; No Holidays)

Concrete	Immersion Time (days)	Medium and Weight Change(%)			Remarks
		DI Water	3% H ₂ SO ₄	30% H ₂ SO ₄	
Wet	10	0.14	0.30	1.40	Acids are higher
	30	0.35	0.50	3.00	Acids are higher
	60	0.50	0.70	3.70	Acids are higher
Remarks	Up to 60 days of testing	Weighted gained. No visible damage	Weight gained. Infiltration. No visible damage	Weight gained. Infiltration. No visible damage	Weight gained. Much less than dry bricks. No visible damage.

*50% of specimen was submerged in liquid.

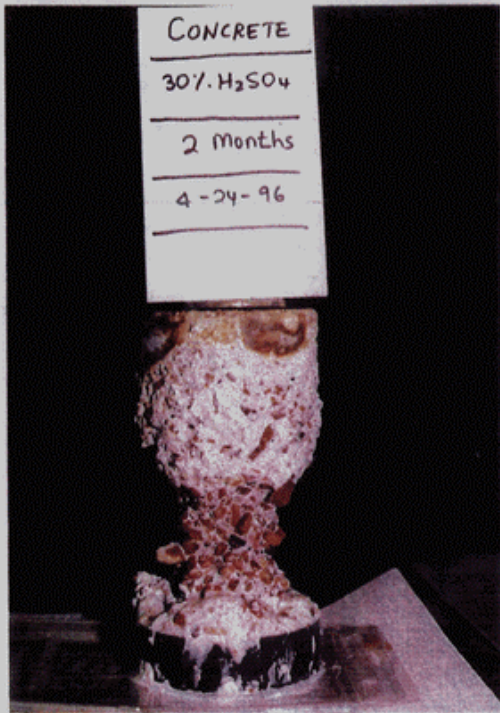

(a) 30% Sulfuric Acid

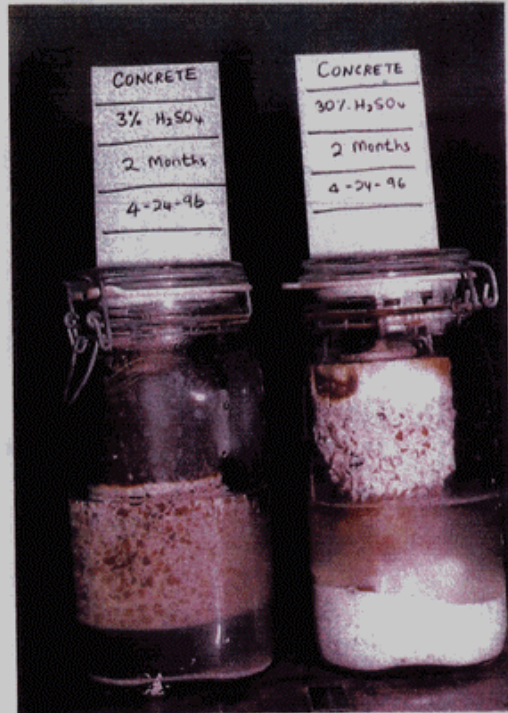

(b) Comparison of 3% and 30% Sulfuric Acid

Figure A3. Chemical Attack on Cement Concrete Cylinder After Two months of Submersion (a) 30% Sulfuric Acid and (b) Comparison of 3% and 30% Sulfuric Acid (Modified ASTM G20-88)

Table A.5. Minimum and Maximum Strengths of Concrete Cylinders, Blocks and Clay Bricks

Materials	Curing Time (days)	Compressive Strength (psi) Dry	Compressive Strength (psi) Wet	Flexural Strength (psi) Dry	Flexural Strength (psi) Wet	Tensile Strength (psi) Dry	Tensile Strength (psi) Wet
Concrete Cylinder (No. Specimen)	28	6900 (2)	4800 (2)	Not applicable	Not applicable	Not applicable	Not applicable
Concrete Block (No. Specimen)	28	Not applicable	Not applicable	918 - 1462 (2)	1244 - 1292 (2)	Not available	353 - 550 (8)
Clay Brick (No. Specimen)		Not applicable	Not applicable	1168 - 1184 (2)	994 - 995 (2)	Not available	369 - 468 (2)
Remarks		Information for quality control	Information for quality control	Related to ASTM C321-94 Bonding Test	Related to ASTM C321-94 Bonding Test	Related to ASTM D4541-85 Bonding Test	Related to ASTM D4541-85 Bonding Test

APPENDIX: B

Full Scale Test: Hydrostatic Test

Summary: Application and Performance

In order to evaluate the potential of applying the coating SPECTRASHIELD LINER on dry surface (Simulating new construction or above water table application) and wet surface (under a hydrostatic water back pressure of 15 psi (equivalent to 32 ft. of water)) the full scale tests were performed. Performance of coated surfaces was evaluated over a period of five months (December 1, 1995 to May 3, 1996).

Application

Coating was applied successfully under dry and wet (hydrostatic test) conditions respectively. Dry coating was done at the coating manufacturers' site in Florida and transported back to the test site at UH. Wet coating was applied with ease in for steps at the University of Houston testing site (Dec. 1, 1995). Coatings were inspected during and immediately after application. No immediate defects (blistering, cracking, discoloration, spalling, sticking to the finger after 48 hours of application, scratch off) were observed on the dry coated surfaces. Except for very small area of fine hard blisters (Table B3, caused by excess polymer) no other defect was observed in the wet coating.

Rating:

- (i) Dry coating (SPECTRASHIELD LINER) passed* the application test. Coverage of the concrete surface was good.

- (ii) Wet coating (SPECTRASHIELD LINER) passed* the application test. Coverage** of the concrete surface was good.

*Passing means (1) no blistering, (2) no cracking, (3) no discoloration, (4) no spalling, (5) not stick to the finger after 48 hours of application and (6) cannot scratch-off.

**Coverage rating was selected from good, satisfactory or bad. Good rating means no visible spot of concrete surface; Satisfactory rating means a few small spots of visible concrete surface; Bad rating means several spots of visible concrete surface.

Performance

The coatings were tested under a hydrostatic pressure of 105 kPa (15 psi) over a period of five months. For inspection purposes each eight feet length of 900 mm (36 in.) pipe was divided into 12 (4 X 3) sections of approximate area of 900 sq. in (6.3 sq. ft.) each. The coatings were inspected on a regular basis to identify any visible defects and mapped on 4 X 3 format as shown in Table B1. Table B1 summaries the performance of coating SPECTRASHIELD LINER (Dry) in each section of the pipe. In Fig. B1 photographs of the center strip is shown. Each section was evaluated for (i) overall condition (ii) surface texture (iii) blistering (iv) cracking (v) change in color and (vi) quality of finish. In all of these categories the two coatings performed well. The performance of the SPECTRASHIELD LINER (Wet) is summarized in Tables B2 and B3 with a photograph in Fig. B2.

Overall Rating:

- (i) Dry coating (SPECTRASHIELD LINER) passed the performance test in all categories

((i) through (vi)).

- (ii) Wet coating (SPECTRASHIELD LINER) passed the performance test in all categories

((i) through (vi)).

Performance Rating Criteria

- (i) Overall Condition (appearance) : good, satisfactory, bad

- (ii) Surface Texture: smooth, rough

- (iii) Blistering: yes, no (see attached table for distribution and density)

- (iv) Cracking: yes, no (see attached table for distribution and density)

(v) Change in color: yes, no

(vi) Overall Finish (quality of the job): good, satisfactory, bad

Overall Rating: Pass, Satisfactory, Fail

Table B1. Inspection of Concrete Coated with SPECTRASHIELD LINER After Five Months

Initial Condition : Dry

Inspection Date : 05/03/96

	1	2	3	
Crown	Coverage: Good Condition: Good Surface texture: Smooth with wrinkle Blister: No Crack: No Color: Pink Finish: Excellent	Coverage: Good Condition: Good Surface texture: Smooth with wrinkle Blister: No Crack: No Color: Pink Finish: Excellent	Coverage: Good Condition: Good Surface texture: Smooth with wrinkle Blister: No Crack: No Color: Pink Finish: Excellent	1
Spring Line	Coverage: Good Condition: Good Surface texture: Smooth with wrinkle Blister: No Crack: No Color: Pink Finish: Excellent	Coverage: Good Condition: Good Surface texture: Smooth with wrinkle Blister: No Crack: No Color: Pink Finish: Excellent	Coverage: Good Condition: Good Surface texture: Smooth with wrinkle Blister: No Crack: No Color: Pink Finish: Excellent	2
Invert	Coverage: Good Condition: Good Surface texture: Smooth with wrinkle Blister: No Crack: No Color: Pink Finish: Excellent	Coverage: Good Condition: Good Surface texture: Smooth with wrinkle Blister: No Crack: No Color: Pink Finish: Excellent	Coverage: Good Condition: Good Surface texture: Smooth with wrinkle Blister: No Crack: No Color: Pink Finish: Excellent	3
Spring Line	Coverage: Good Condition: Good Surface texture: Smooth with wrinkle Blister: No Crack: No Color: Pink Finish: Excellent	Coverage: Good Condition: Good Surface texture: Smooth with wrinkle Blister: No Crack: No Color: Pink Finish: Excellent	Coverage: Good Condition: Good Surface texture: Smooth with wrinkle Blister: No Crack: No Color: Pink Finish: Excellent	4
Crown	1	2	3	

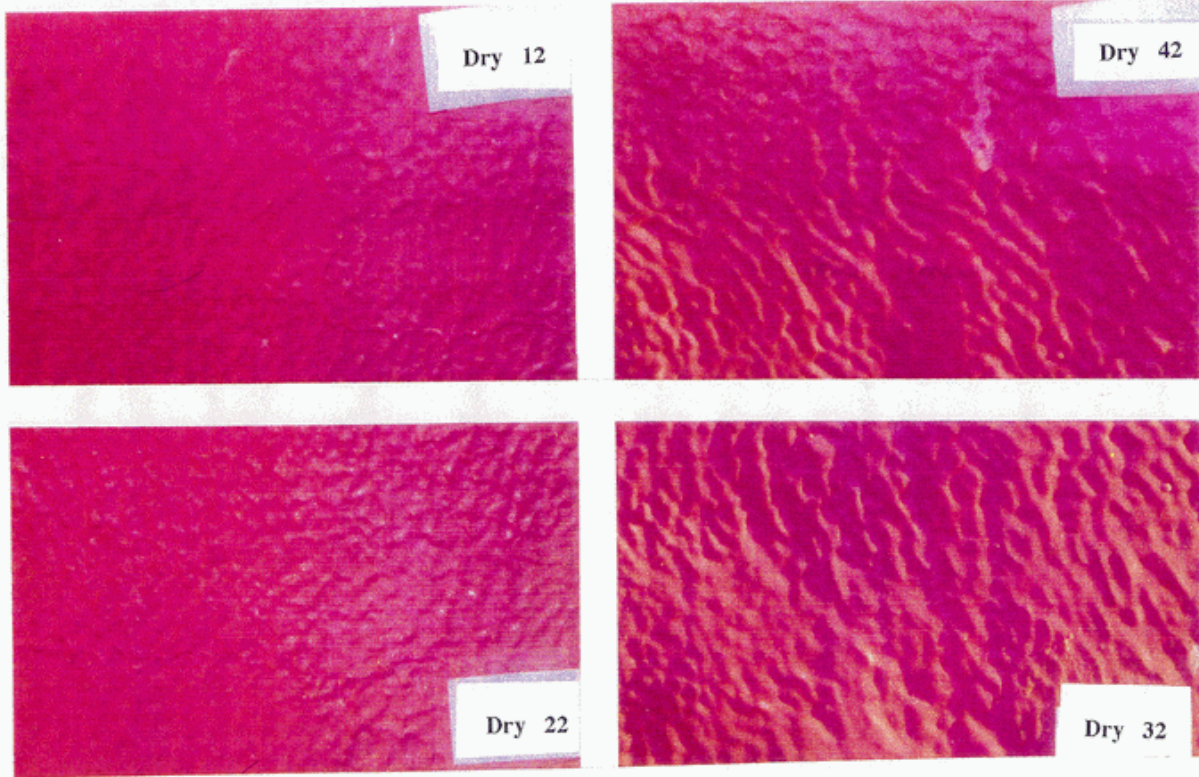

Figure B1. Middle Section of the Concrete Pipe Coated with SPECTRASHIELD LINER (Dry Coating) After Five Months of Testing

Table B2. Inspection of Concrete Coated with SPECTRASHIELD LINER After Five Months

Initial Condition : Wet

Inspection Date : 05/03/96

	1	2	3	
Crown	Coverage: Good Condition: Good Surface texture: Smooth with wrinkle Blister: No Crack: No Color: Pink Finish: Excellent	Coverage: Good Condition: Good Surface texture: Smooth with wrinkle Blister: No Crack: No Color: Pink Finish: Excellent	Coverage: Good Condition: Good Surface texture: Smooth with wrinkle Blister: No Crack: No Color: Pink Finish: Excellent	1
Spring Line	Coverage: Good Condition: Good Surface texture: Smooth with wrinkle Blister: No Crack: No Color: Pink Finish: Excellent	Coverage: Good Condition: Good Surface texture: Smooth with wrinkle Blister: No Crack: No Color: Pink Finish: Excellent	Coverage: Good Condition: Good Surface texture: Smooth with wrinkle Blister: No Crack: No Color: Pink Finish: Excellent	2
Invert	Coverage: Good Condition: Good Surface texture: Smooth with wrinkle Blister: No Crack: No Color: Pink Finish: Excellent	Coverage: Good Condition: Good Surface texture: Smooth with wrinkle Blister: Yes--very small blisters Crack: No Color: Pink Finish: Excellent	Coverage: Good Condition: Good Surface texture: Smooth with wrinkle Blister: No Crack: No Color: Pink Finish: Excellent	3
Spring Line	Coverage: Good Condition: Good Surface texture: Smooth with wrinkle Blister: No Crack: No Color: Pink Finish: Excellent	Coverage: Good Condition: Good Surface texture: Smooth with wrinkle Blister: No Crack: No Color: Pink Finish: Excellent	Coverage: Good Condition: Good Surface texture: Smooth with wrinkle Blister: No Crack: No Color: Pink Finish: Excellent	4
Crown	1	2	3	

Table B3. Defects on Concrete Coated with SPECTRASHIELD LINER After Five Months

Initial Condition : Wet

Inspection Date : 05/03/96

	1	2	3	
Crown				1
Spring Line				2
Invert		Very small blemishes 		3
Spring Line				4
Crown		2	3	

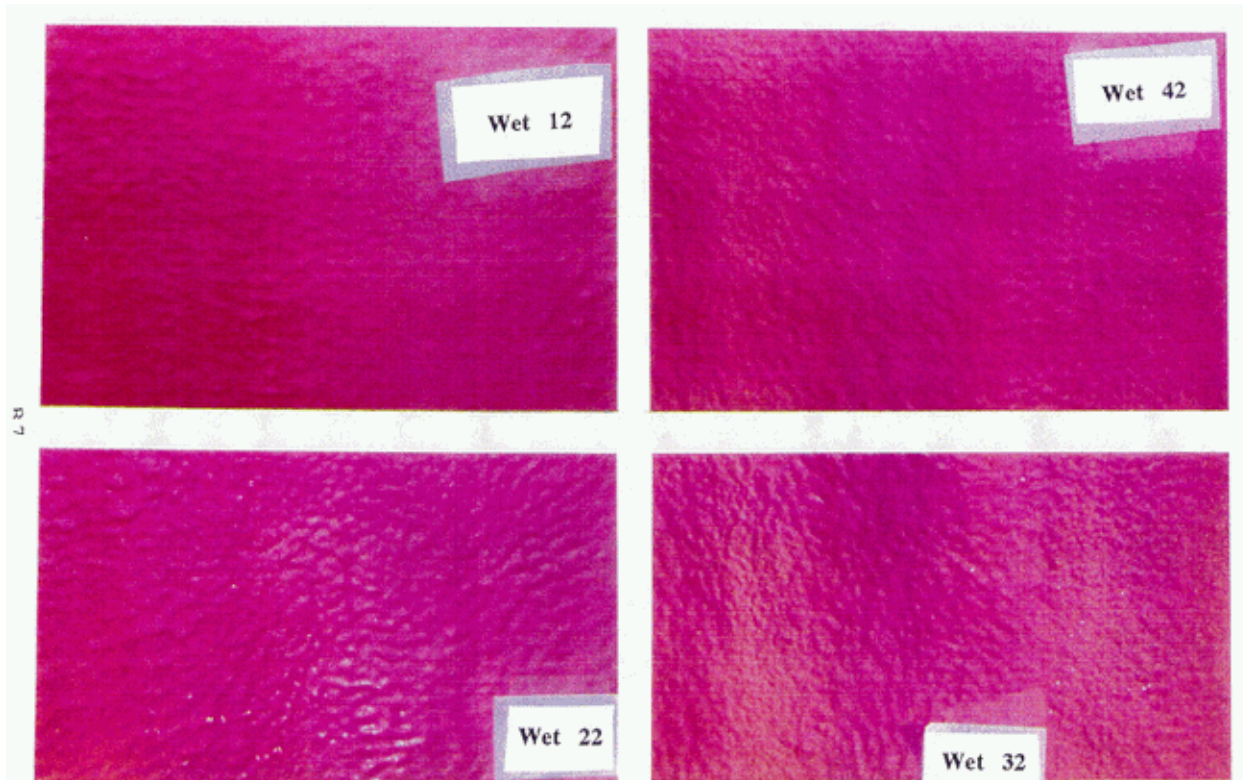

Figure B2. Middle Section of the Concrete Pipe Coated with SPECTRASHIELD LINER (Wet Coating) After Five Months of Testing

APPENDIX: C

Laboratory Test: Holiday Test (Modified ASTM G20-88)

Summary: Sulfuric Acid Resistance

Total Concrete Cylinders = 32

Total Brick Cylinders = 27

In order to evaluate the performance of SPECTRASHIELD LINER (dry and wet)

coatings, coated concrete cylinders and clay bricks were tested with and without holidays in water, 3% sulfuric acid and 30% sulfuric acid solutions. Performance of both coatings were evaluated over a period of six months from December 1, 1995 to June 1, 1996 in this report. Total of 32 concrete and 27 clay brick coated specimens were tested. All specimens passed the vapor phase test and liquid phase results are summarized in Tables C1 through C8. The tests are being continued on the passing specimens and the City of Houston will be updated on the test results.

SPECTRASHIELD LINER (Dry Coating)

Concrete

One month: All specimens passed the test.

Six months: All specimens with and without holiday passed the test. Specimens in 30% sulfuric acid changed color from original pink to dark brown.

Clay Brick

One month: All specimens passed the test.

Six months: All specimens passed the test. Specimens in 30% sulfuric acid has color Change.

SPECTRASHIELD LINER (Wet Coating)

Concrete

One month: All specimens passed the test.

Six months: All specimens with and without holiday passed the test. All specimens in

30% sulfuric acid had color changes.

Clay Brick

One month: All specimens passed the test.

Six months: All specimens passed the test. Specimens in 30% sulfuric acid had color changes.

Rating Criteria

Pass (P): No visible blister. No discoloration. No cracking.

Pass with Blister (PB): Visible blister (very small). No discoloration. No cracking.

Blister (B): Visible blister up to one inch in diameter. No discoloration. No cracking.

Failure (F): Blister with diameter greater than one inch and/or cracking of coating at the holiday.

Discoloration (DC): Change in color of the coating.

Table C1. Holiday Test Results (Liquid Phase) for SPECTRASHIELD LINER Coated Concrete (Dry) After One Month of Immersion (Modified ASTM G20-88)

Concrete	Holiday	Medium (No. of Specimens)			Total No. %(P/B/F)	Remarks
		DI Water	3% H ₂ SO ₄	30% H ₂ SO ₄		
Dry (Spectrashield Liner)	No Holiday	P(2)	P(2)	P(2)	6 (100/0/0)	Pass
	1/4 inch	P(1)	P(2)	P(2)	5 (100/0/0)	Pass
	1/2 inch	P(1)	P(2)	P(2)	5 (100/0/0)	Pass
	1/8 inch	---	---	---	---	---
Total No. %(P/B/F)		4 (100/0/0)	6 (100/0/0)	6 (100/0/0)	16 (100/0/0)	Total of 16 specimens tested
Remarks	After one month of immersion	Pass	Pass	Pass		All Pass(100%)

P=Pass; B=Blister; F=Failure; PB=Pass with Blister.

Table C2. Holiday Test Results (Liquid Phase) for SPECTRASHIELD LINER Coated Concrete (Wet) After One Month of Immersion (Modified ASTM G20-88)

Concrete	Holiday	Medium (No. of Specimens)			Total No. %(P/B/F)	Remarks
		DI Water	3% H ₂ SO ₄	30% H ₂ SO ₄		
Wet (Spectrashield Liner)	No Holiday	P(2)	P(2)	P(2)	6 (100/0/0)	Pass
	1/4 inch	P(1)	P(2)	P(2)	5 (100/0/0)	Pass
	1/2 inch	P(1)	P(2)	P(2)	5 (100/0/0)	Pass
	1/8 inch	---	---	---	---	---
Total No. %(P/B/F)		4 (100/0/0)	6 (100/0/0)	6 (100/0/0)	16 (100/0/0)	Total of 16 specimens tested
Remarks	After one month of immersion	Pass	Pass	Pass		All Pass(100%)

P=Pass; B=Blister; F=Failure; PB=Pass with Blister.

Table C3. Holiday Test Results (Liquid Phase) for SPECTRASHIELD LINER Coated Concrete (Dry) After Six (6) Months of Immersion (Modified ASTM G20-88)

Concrete	Holiday	Medium (No. of Specimens)			Total No. %(P/B/F)	Remarks
		DI Water	3% H ₂ SO ₄	30% H ₂ SO ₄		
Dry (Spectrashield Liner)	No Holiday	P(2)	P(2)	PDC(2)	6 (100/0/0)	Pass
	1/4 inch	P(1)	P(2)	PDC(2)	5 (100/0/0)	Pass
	1/2 inch	P(1)	P(2)	PDC(2)	5 (100/0/0)	Pass
	1/8 inch	---	---	---	---	---
Total No. %(P/B/F)		4 (100/0/0)	6 (100/0/0)	6 (100/0/0)	16 (100/0/0)	Total of 16 specimens tested
Remarks	After six months of immersion	Pass	Pass	Pass with Discolor		All Pass(100%)

P=Pass; B=Blister; F=Failure; PB=Pass with Blister; PDC= Pass with Discoloration in the Liquid Phase.

Table C4. Holiday Test Results (Liquid Phase) for SPECTRASHIELD LINER Coated Concrete (Wet) After Six (6) Months of Immersion (Modified ASTM G20-88)

Concrete	Holiday	Medium (No. of Specimens)			Total No. %(P/B/F)	Remarks
		DI Water	3% H ₂ SO ₄	30% H ₂ SO ₄		
Wet (Spectrashield Liner)	No Holiday	P(2)	P(2)	PDC(2)	6 (100/0/0)	Pass
	1/4 inch	P(1)	P(2)	PDC(2)	5 (100/0/0)	Pass
	1/2 inch	P(1)	P(2)	PDC(2)	5 (100/0/0)	Pass
	1/8 inch	---	---	---	---	---
Total No. %(P/B/F)		4 (100/0/0)	6 (100/0/0)	6 (100/0/0)	16 (100/0/0)	Total of 16 specimens tested
Remarks	After six months of immersion	Pass	Pass	Pass with Discolor		All Pass(100%)

P=Pass; B=Blister; F=Failure; PB= Pass with Blister; PDC= Pass with Discoloration in the Liquid Phase.

Table C5. Holiday Test Results (Liquid Phase) for SPECTRASHIELD LINER Coated Clay Brick (Dry) After One Month of Immersion (Modified ASTM G20-88)

Clay Brick	Holiday	Medium (No. of Specimens)			Total No. %(P/B/F)	Remarks
		DI Water	3% H ₂ SO ₄	30% H ₂ SO ₄		
Dry (Spectrashield Liner)	No Holiday	---	P(2)	P(2)	4(100/0/0)	Pass
	1/4 inch	---	---	---	---	---
	1/2 inch	P(1)	P(2)	P(2)	5(100/0/0)	Pass
	1/8 inch	---	---	---	---	---
Total No. %(P/B/F)		1 (100/0/0)	4 (100/0/0)	4 (100/0/0)	9 (100/0/0)	Total of 9 specimens tested
Remarks	After one month of immersion	Pass	Pass	Pass		All Pass(100%)

Pass =P; B = Blister; F = Failure; Pass with Blister =PB.

Table C6. Holiday Test Results (Liquid Phase) for SPECTRASHIELD LINER Coated Concrete (Wet) After One Month of Immersion (Modified ASTM G20-88)

Clay Brick	Holiday	Medium (No. of Specimens)			Total No. %(P/B/F)	Remarks
		DI Water	3% H ₂ SO ₄	30% H ₂ SO ₄		
Wet (Spectrashield Liner)	No Holiday	P(2)	P(2)	P(2)	6 (100/0/0)	Pass
	1/4 inch	---	---	---	---	---
	1/2 inch	P(4)	P(4)	P(4)	12 (100/0/0)	Pass
	1/8 inch	---	---	---	---	---
Total No. %(P/B/F)		6 (100/0/0)	6 (100/0/0)	6 (100/0/0)	18 (100/0/0)	Total of 18 specimens tested
Remarks	After one month of immersion	Pass	Pass	Pass		All Pass(100%)

P=Pass; B=Blister; F=Failure; PB=Pass with Blister.

Table C7. Holiday Test Results (Liquid Phase) for SPECTRASHIELD LINER Coated Clay Brick (Dry) After Six (6) Months of Immersion (Modified ASTM G20-88)

Clay Brick	Holiday	Medium (No. of Specimens)			Total No. %(P/B/F)	Remarks
		DI Water	3% H ₂ SO ₄	30% H ₂ SO ₄		
Dry (Spectrashield Liner)	No Holiday	---	P(2)	PDC(2)	4 (100/0/0)	Pass
	1/4 inch	---	---	---	---	---
	1/2 inch	P(1)	P(2)	PDC(2)	5 (100/0/0)	Pass
	1/8 inch	---	---	---	---	---
Total No. %(P/B/F)		1 (100/0/0)	4 (100/0/0)	4 (100/0/0)	9 (100/0/0)	Total of 9 specimens tested
Remarks	After six months of immersion	Pass	Pass	Pass with Discoloration		All Pass(100%)

P=Pass; B=Blister; F=Failure; PB=Pass with Blister, PDC=Pass with Discoloration in the Liquid Phase.

Table C8. Holiday Test Results (Liquid Phase) for SPECTRASHIELD LINER Coated Concrete (Wet) After Six (6) Months of Immersion (Modified ASTM G20-88)

Clay Brick	Holiday	Medium (No. of Specimens)			Total No. %(P/B/F)	Remarks
		DI Water	3% H ₂ SO ₄	30% H ₂ SO ₄		
Wet (Spectrashield Liner)	No Holiday	P(2)	P(2)	PDC(2)	6 (100/0/0)	Pass
	1/4 inch	---	---	---	---	---
	1/2 inch	P(4)	P(4)	PDC(4)	12 (100/0/0)	Pass
	1/8 inch	---	---	---	---	---
Total No. %(P/B/F)		6 (100/0/0)	6 (100/0/0)	6 (100/0/0)	18 (100/0/0)	Total of 18 specimens tested
Remarks	After six months of immersion	Pass	Pass	Pass with Discoloration		All Pass (100%)

P=Pass; B=Blister; F=Failure; PDC=Pass with Discoloration in the Liquid Phase.

APPENDIX: D

Laboratory Test: Bonding Test

ASTM D4541-85 AND ASTM C321-94)

Summary: Tensile Bonding Strength

Total D4541-85 Tests = 14

Total C321-94 Test = 12

Bonding strengths of SPECTRASHIELD LINER (dry and wet) coatings with concrete and clay brick were determined according to ASTM D4541-85 and ASTM C321-94 testing methods over a period of twelve and nine months respectively. All the specimens were cured under water. Both dry and wet specimens were coated to simulate the Full-scale testing conditions. Performance of both coatings were evaluated started December 1, 1995 and the results are included in this report. Of the 26 bonding tests, 14 tests were with concrete and 12 with clay brick. Two in situ bonding tests were done on the coated pipes with the hydrostatic pressure still on. The results are summarized in Tables D1 through D8 with the type of failure. Several more test are planned and the City of Houston will be updated on the test results.

SPECTRASHIELD LINER (Dry Coating)

Concrete

ASTM D4541-85: All the failures were Type 2 where the coating failed in direct tension. Average coating strength from laboratory test was less than 61 psi (0.4 MPa)(Table D1). In situ bonding strength was 71 psi (0.5 MPa) and the failure was in the coating (Type 2).

ASTM C321-94 (With Primer Only): All failures were Type 1 where the concrete block failed in bending. The bonding strength did not change much with time. Average bonding strength from laboratory tests was greater than 225 psi (1.6 MPa) (Table D5).

Summary: All coating (four layers) failures from ASTM D4541-85 test were Type 2. All primer failures from ASTM C321-94 test were Type 1. The average coating strength from

ASTM D4541-85 was 61 psi (0.4 MPa). The Bonding strength of primer from ASTM C321-94 test was greater than 225 psi (1.6 MPa). In situ coating strength was 71 psi (0.5 MPa) and the coating failed (Type 2). Bonding strength of primer with dry concrete was good. Poor coating (4 layer system) strength.

Clay Brick

ASTM D4541-85: All the failures were Type 2 where the coating failed in direct tension (Table D3). Coating strength varied from 60 to 180 psi.

ASTM C 321-94 (With Primer Only): All the failures were Type 1 indicating good bonding strength with the primer. The bonding strength varied from 265 to 317 psi with an average strength of 283 psi (2.0 MPa) (Table D7).

Summary: All coating (four layers) failures from ASTM D4541-85 test were Type 2. All primer failures from ASTM C321-94 were Type 1. The bonding strength of primer from ASTM C321-94 test was greater than 283 psi (2.0 MPa). Bonding strength of primer with dry clay brick was good. Poor coating (4 layer system) strength.

SPECTRASHIELD LINER (Wet Coating)

Concrete

ASTM D4541-85: All the failures were Type 2 where the coating failed in direct tension. Average coating strength from laboratory tests was 51 psi (0.35 MPa)(Table D2).

ASTM C321-94 (With Primer Only): All failures were Type 1. The bonding strength did not change much with curing time. Average bonding strength from laboratory tests was greater than 223 psi (1.5 MPa) (Table D6).

Summary: All coating (four layers) failures from ASTM D4541-85 test were Type 2. All primer failures from ASTM C321-94 test were Type 1. The average coating strength from ASTM D4541-85 was 51 psi (0.35 MPa). The bonding strength of primer from ASTM C321-94 test was greater than 223 psi (1.5 MPa). Bonding strength of primer with wet concrete was good. Poor coating (4 layer system) strength.

Clay Brick

ASTM D4541-85: All the failures were Type 2 where the coating failed in direct tension. The coating strength varied from 24 to 95 psi with an average of 59 psi (0.4 MPa) (Table D4).

ASTM C321-94 (With Primer Only): All failures were Type 1. The bonding strength varied from 249 to 358 psi with an average of 289 psi (2.0 MPa) Table D8).

Summary: All coating (four layers) failures from ASTM D4541-85 test were Type 2. All primer failures from ASTM C321-94 test were Type 1. The average coating strength from ASTM D4541-85 was 59 psi (0.4 MPa). The bonding strength of primer from ASTM C321-94 test was greater than 289 psi (2.0 MPa). Bonding strength of primer with wet clay brick was good. Poor coating (4 layer system) strength.

ASTM D-4541 Failure Patterns









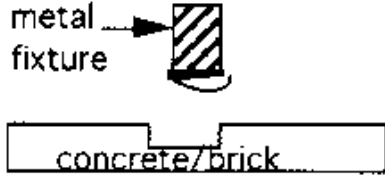

<p>Type 1 Brick/concrete failure.</p>	 <p>metal fixture →  concrete/brick</p>
<p>Type 2 Coating Failure .</p>	 <p>metal fixture →  coating concrete /brick</p>
<p>Type 3 Bonding interface Failure .</p>	 <p>metal fixture →  coating concrete/brick</p>
<p>Type 4 Bonding + Brick/Concrete Failure .</p>	 <p>metal fixture →  coating concrete/brick</p>
<p>Type 5 Bonding + Coating Failure .</p>	 <p>metal fixture →  coating concrete/brick</p>

Figure D1. Types of Failure Modes During the Bonding Test ASTM D4541-85

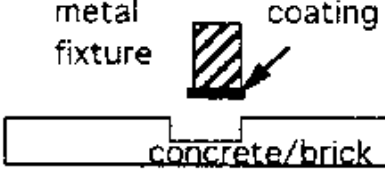
Table D1. Bonding Strength and Type of Failure of SPECTRASHIELD LINER Coating with Dry Concrete (ASTM D4541-85)

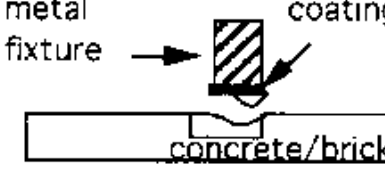
Concrete	Curing Time (days)	Failure Modes					Failure Strength (psi)
		Type 1	Type 2	Type 3	Type 4	Type 5	
Dry (Spectrashield Liner)	21		X				62
	23		X				40
	158 *		X				71 *
	330		X				80
Total No. (% Failure)		0 (0%)	3 (100%)	0 (0%)	0 (0%)	0 (0%)	Total of 3 specimens tested.
Remarks	Up to twelve (12) months	None	Poor coating strength	None	None	None	100% Type 2 failure. Coating strength doesn't change. Average strength was 61 psi (0.4 MPa).

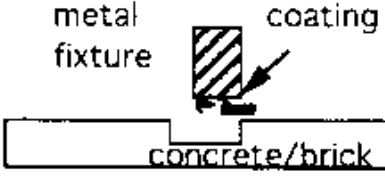
Type 1 = Concrete failure; Type 2 = Coating failure; Type 3 = Bonding failure;
Type 4 = Combined concrete and bonding failure; Type 5 = Combined coating and bonding failure

* In situ Test.

Table D2. Bonding Strength and Type of Failure of SPECTRASHIELD LINER Coating with Wet Concrete (ASTM D4541-85)

Concrete	Curing Time (days)	Failure Modes					Failure Strength (psi)
		Type 1	Type 2	Type 3	Type 4	Type 5	
Wet (Spectrashield Liner)	21		X				60
	23		X				20
	158 *		X				51 *
	330		X				72
Total No. (% Failure)		0 (0%)	3 (100%)	0 (0%)	0 (0%)	0 (0%)	Total of 3 specimens tested.
Remarks	Up to twelve (12) months	None	Poor coating strength	None	None	None	100% Type 2 failure. Coating strength doesn't change with time. Coating strength varied from 20 to 72 psi.

Type 1 = Concrete failure; Type 2 = Coating failure; Type 3 = Bonding failure;
Type 4 = Combined concrete and bonding failure; Type 5 = Combined coating and bonding failure

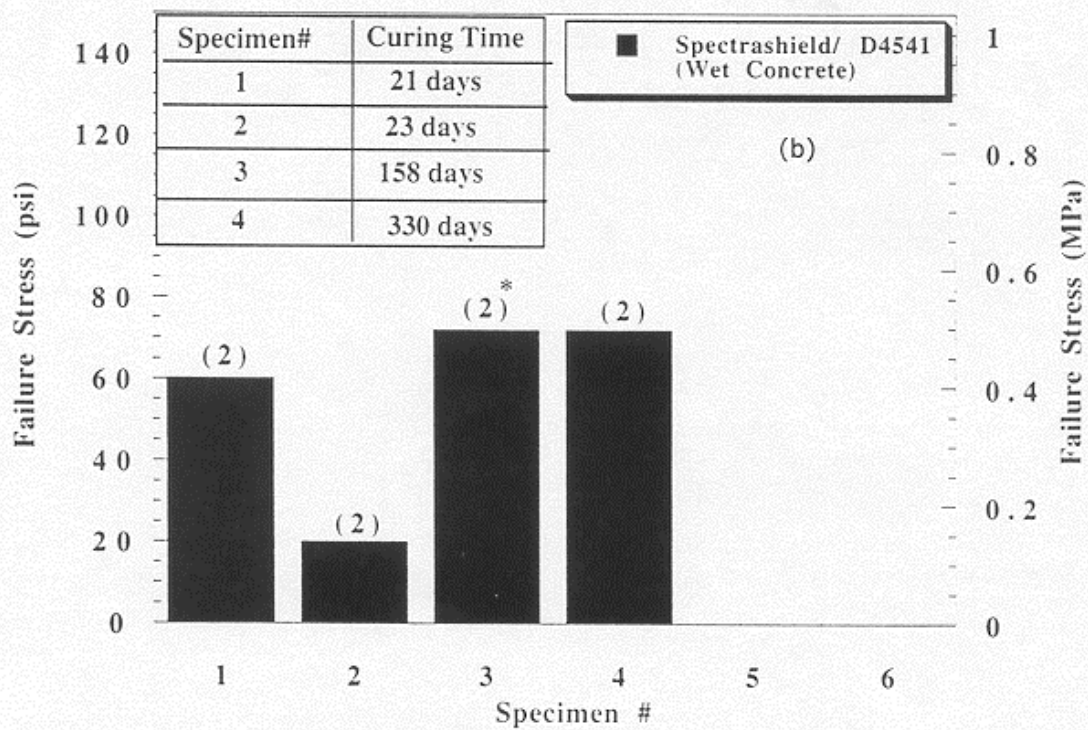
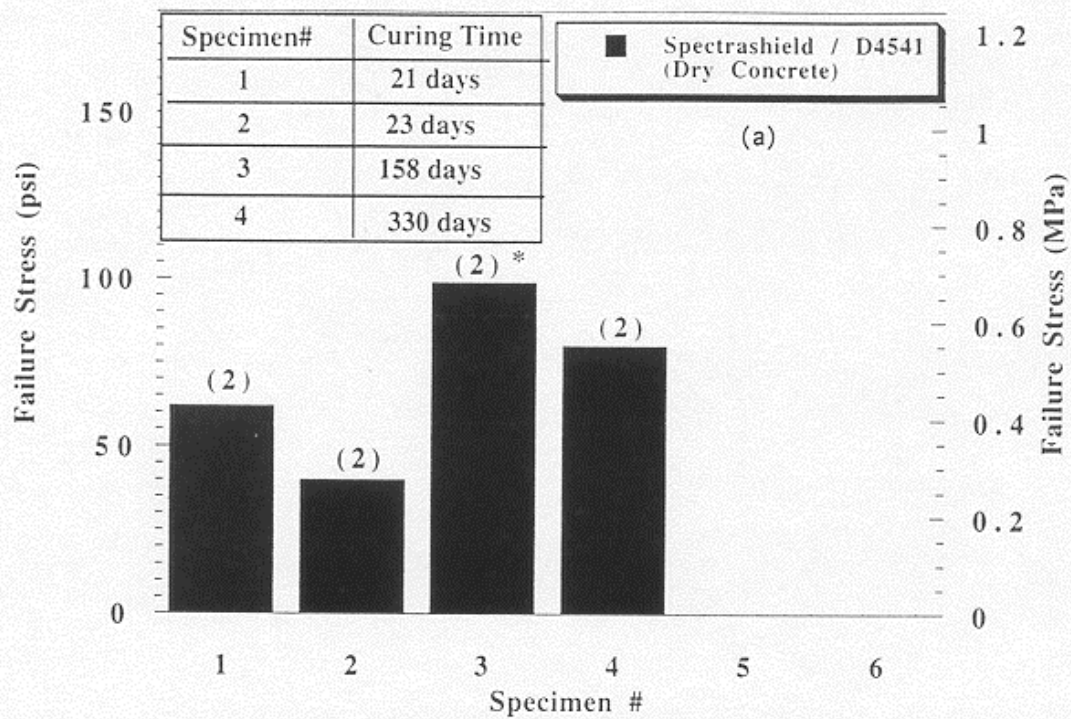

Figure D2. Bonding Strength of SPECTRASHIELD LINER with Concrete and Types of Failures During ASTM D4541-85 Tests (a) Dry and (b) Wet Concrete

Table D3. Bonding Strength and Type of Failure of SPECTRASHIELD LINER Coating with Dry Clay Brick (ASTM D4541-85)

Clay Brick	Curing Time (days)	Failure Modes					Failure Strength (psi)
		Type 1	Type 2	Type 3	Type 4	Type 5	
Dry (Spectrashield Liner)	25		X				180
	25		X				60
	330		X				81
	-	-	-	-	-	-	-
Total No. (% Failure)		0 (0%)	3 (100%)	0 (0%)	0 (0%)	0 (0%)	Total of 3 specimens tested.
Remarks	Up to twelve (12) months	None	Poor coating strength	None	None	None	100% Type 2 failure. Coating strength varied from 60 to 180 psi. Poor coating strength.

Type 1 = Clay brick failure; Type 2 = Coating failure; Type 3 = Bonding failure;
 Type 4 = Combined clay brick and bonding failure; Type 5 = Combined coating and bonding failure

Table D4. Bonding Strength and Type of Failure of SPECTRASHIELD LINER Coating with Wet Clay Brick (ASTM D4541-85)

Clay brick	Curing Time (days)	Failure Modes					Failure Strength (psi)
		Type 1	Type 2	Type 3	Type 4	Type 5	
Wet (Spectrashield Liner)	25		X				57
	25		X				95
	330		X				74
	-	-	-	-	-	-	-
Total No. (% Failure)		0 (0%)	3 (100%)	0 (0%)	0 (0%)	0 (0%)	Total of 3 specimens tested.
Remarks	Up to twelve (12) months	None	Poor coating strength	None	None	None	100% Type 2 failure. Poor coating strength. Bonding strength varied from 54 to 95 psi.

Type 1 = Clay brick failure; Type 2 = Coating failure; Type 3 = Bonding failure;
 Type 4 = Combined clay brick and bonding failure; Type 5 = Combined coating and bonding failure

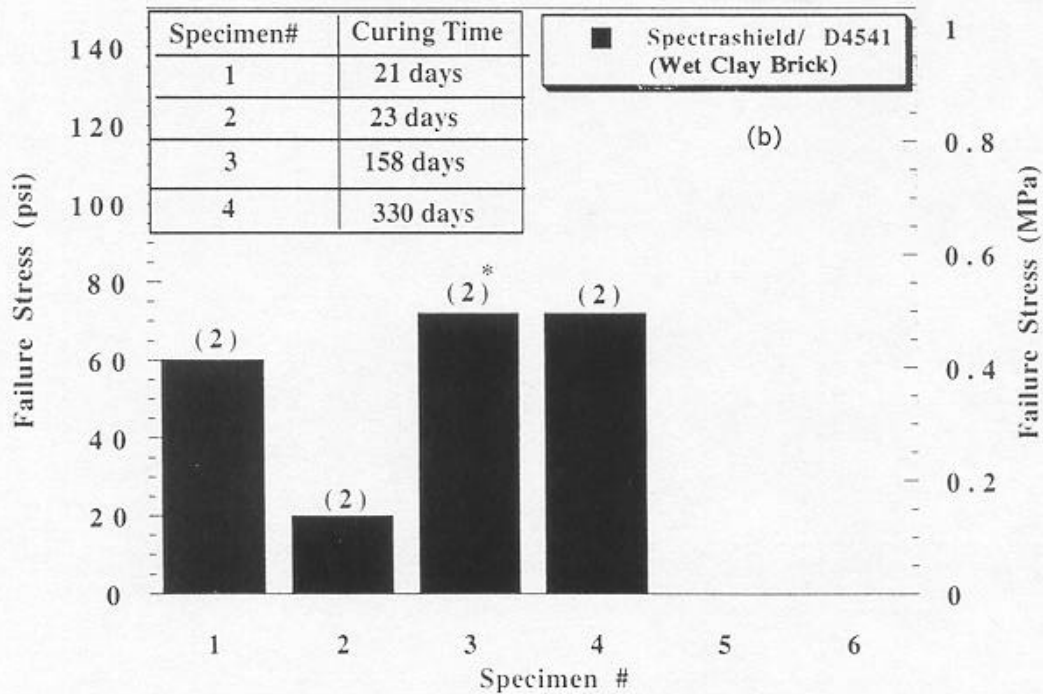
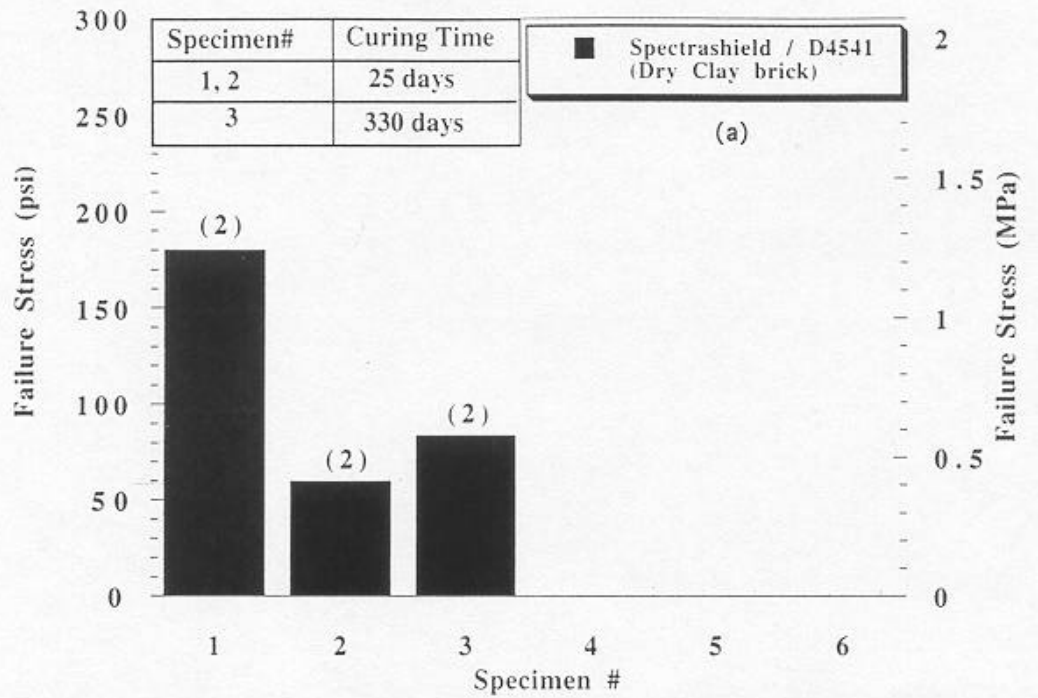

Figure D3. Bonding Strength of SPECTRASHIELD LINER with Clay Brick and Types of Failures During ASTM D4541-85 Tests (a) Dry and (b) Wet Clay Bricks

Table D5. Bonding Strength and Type of Failure of SPECTRASHIELD LINER Coating with Dry Concrete (ASTM C321-94)

Concrete	Curing Time (days)	Failure Modes					Failure Strength (psi)
		Type 1	Type 2	Type 3	Type 4	Type 5	
Dry (Spectrashield Liner)	1	X					182*
	40	X					248*
	240	X					246*
	-	-	-	-	-	-	-
Total No. (% Failure)		3 (100%)	0 (0%)	0 (0%)	0 (0%)	0 (0%)	Total of 3 specimens tested
Remarks	Up to nine (9) months	Good bonding strength	None	None	None	None	100% Type 1 failure. Good bond ing strength. Average bonding strength was greater than 225 psi (1.6 MPa).

Type 1 = Concrete failure; Type 2 = Coating failure; Type 3 = Bonding failure;
Type 4 = Combined concrete and bonding failure; Type 5 = Combined coating and bonding failure

Table D6. Bonding Strength and Type of Failure of SPECTRASHIELD LINER Coating with Wet Concrete (ASTM C321-94)

Concrete	Curing Time (days)	Failure Modes					Failure Strength (psi)
		Type 1	Type 2	Type 3	Type 4	Type 5	
Wet (Spectrashield Liner)	18	X					253*
	40	X					197*
	240	X					219*
	-	-	-	-	-	-	-
Total No. (% Failure)		3 (100%)	0 (0%)	0 (0%)	0 (0%)	0 (0%)	Total of 3 specimens tested
Remarks	Up to nine (9) months	Good bonding strength	None	None	None	None	100% Type 1 failure. Good bond ing strength. Average bonding strength was greater than 223 psi (1.6 MPa).

Type 1 = Concrete failure; Type 2 = Coating failure; Type 3 = Bonding failure;
Type 4 = Combined concrete and bonding failure; Type 5 = Combined coating and bonding failure

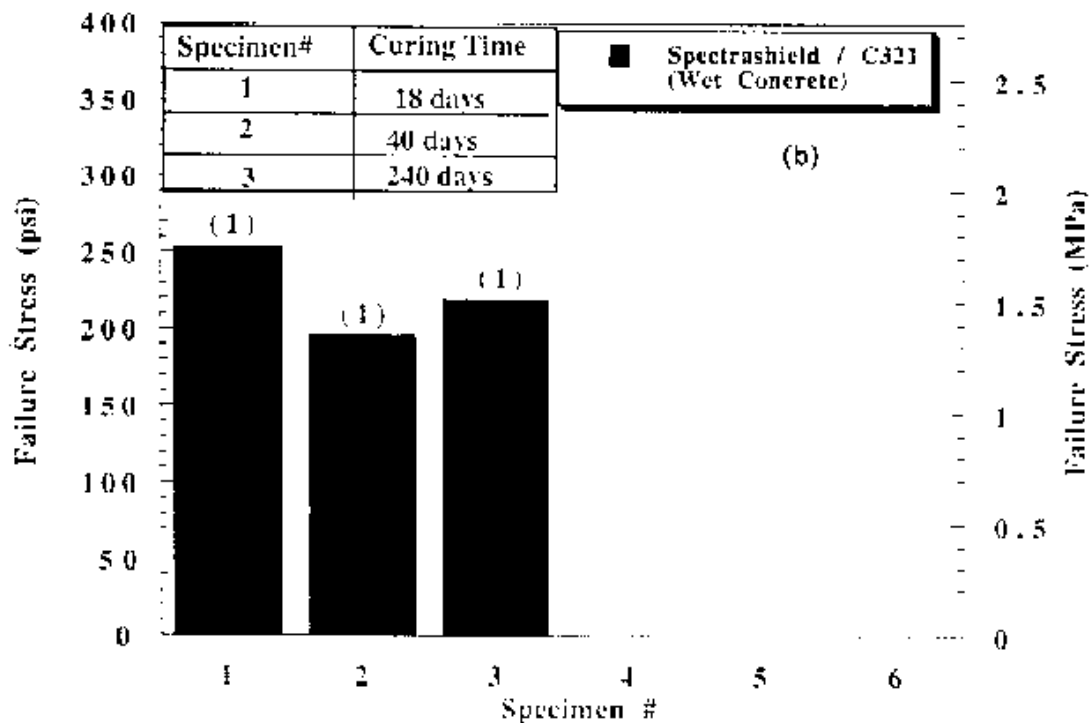
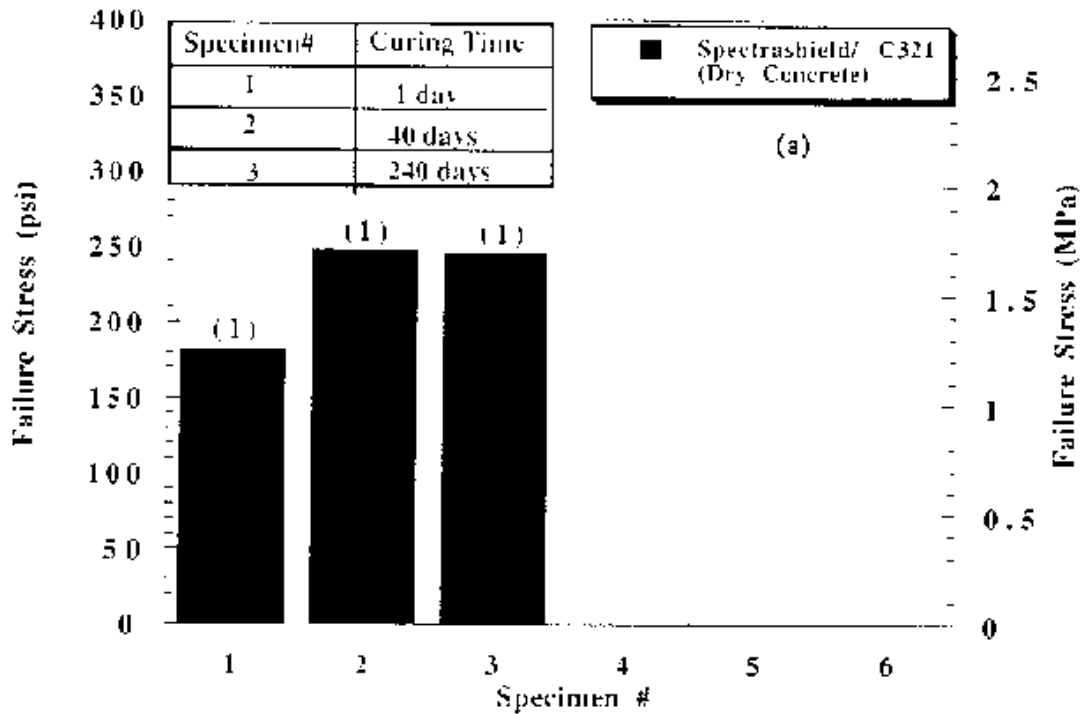

Figure D5. Bonding Strength of SPECTRASHIELD LINER with Concrete and Types of Failures During ASTM C321-94 Tests (a) Dry and (b) Wet Concrete

ASTM C -321 Failure Patterns





<p>Type 1 Brick/concrete failure.</p>	
<p>Type 2 Coating Failure .</p>	
<p>Type 3 Bonding interface Failure .</p>	
<p>Type 4 Bonding + Brick/Concrete Failure</p>	
<p>Type 5 Bonding - Coating Failure .</p>	

Figure D4. Types of Failure Modes During the Bonding Test ASTM C321-94

Table D7. Bonding Strength and Type of Failure of SPECTRASHIELD LINER Coating with Dry Clay Brick (ASTM C321-94)

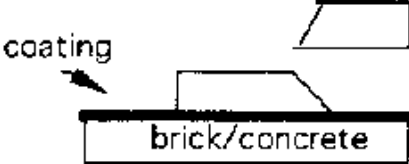
Clay Brick	Curing Time (days)	Failure Modes					Failure Strength (psi)
		Type 1	Type 2	Type 3	Type 4	Type 5	
Dry (Spectrashield Liner)	40	X					317*
	40	X					266*
	260	X					265*
	-	-	-	-	-	-	-
Total No. (% Failure)		3 (100%)	0 (0%)	0 (0%)	0 (0%)	0 (0%)	Total of 3 specimens tested
Remarks	Up to nine (9) months	Good bonding strength	None	None	None	None	100% Type 1 failure. Good bond ing strength. Average strength 283 psi (2.0 MPa)

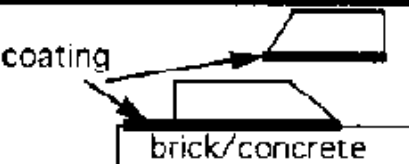
Type 1 = Clay brick failure; Type 2 = Coating failure; Type 3 = Bonding failure;
Type 4 = Combined clay brick and bonding failure; Type 5 = Combined coating and bonding failure

Table D8. Bonding Strength and Type of Failure of SPECTRASHIELD LINER Coating with Wet Clay Brick (ASTM C321-94)

Clay brick	Curing Time (days)	Failure Modes					Failure Strength (psi)
		Type 1	Type 2	Type 3	Type 4	Type 5	
Wet (Spectrashield Liner)	40	X					260*
	40	X					358*
	260	X					249 *
	-	-	-	-	-	-	-
Total No. (% Failure)		3 (100%)	0 (0%)	0 (0%)	0 (0%)	0 (0%)	Total of 3 specimens tested
Remarks	Up to nine (9) months	Good bonding strength	None	None	None	None	100% Type 1 failure. Good bonding strength. Average strength 289 psi (2.0 MPa)

Type 1 = Clay brick failure; Type 2 = Coating failure; Type 3 = Bonding failure;
Type 4 = Combined clay brick and bonding failure; Type 5 = Combined coating and bonding failure

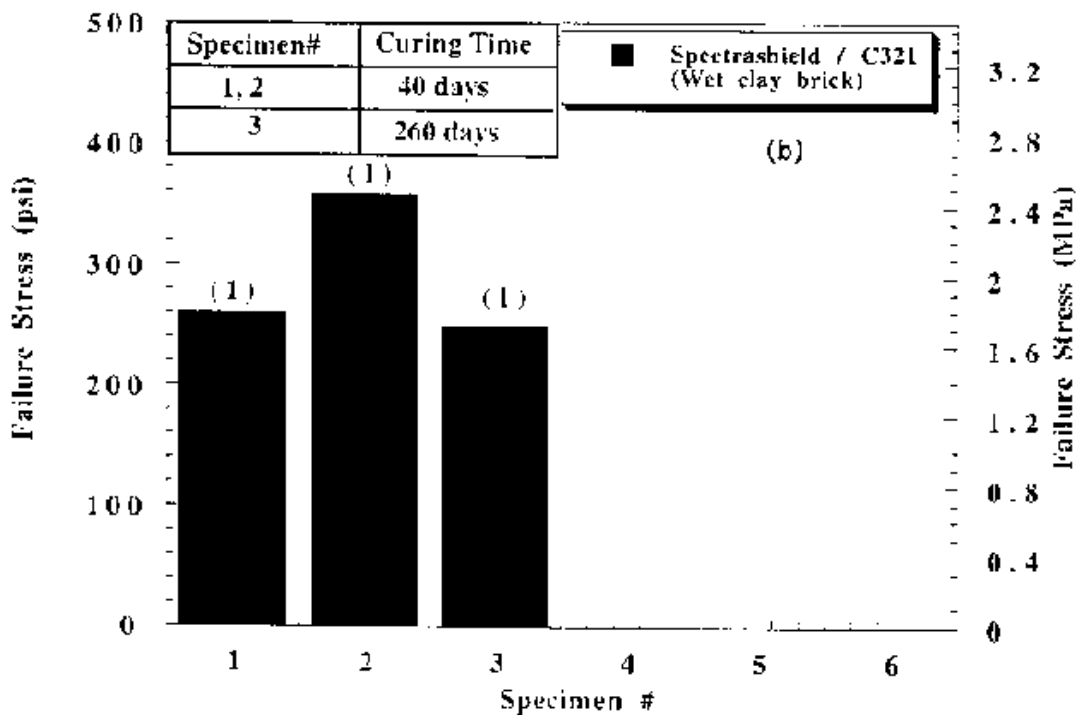
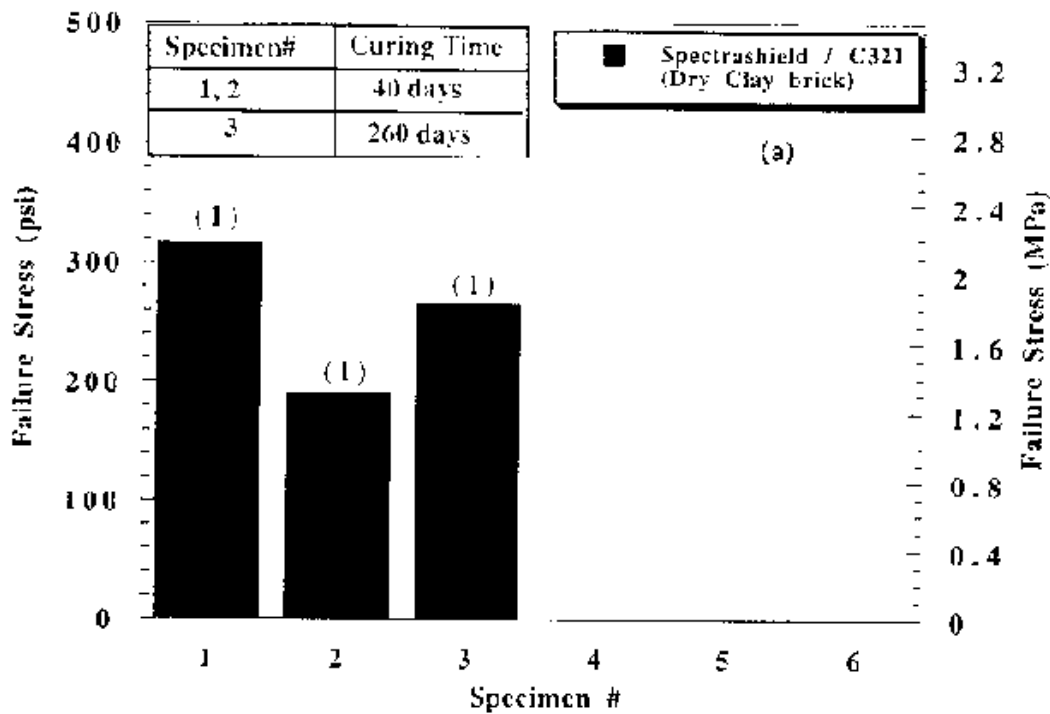
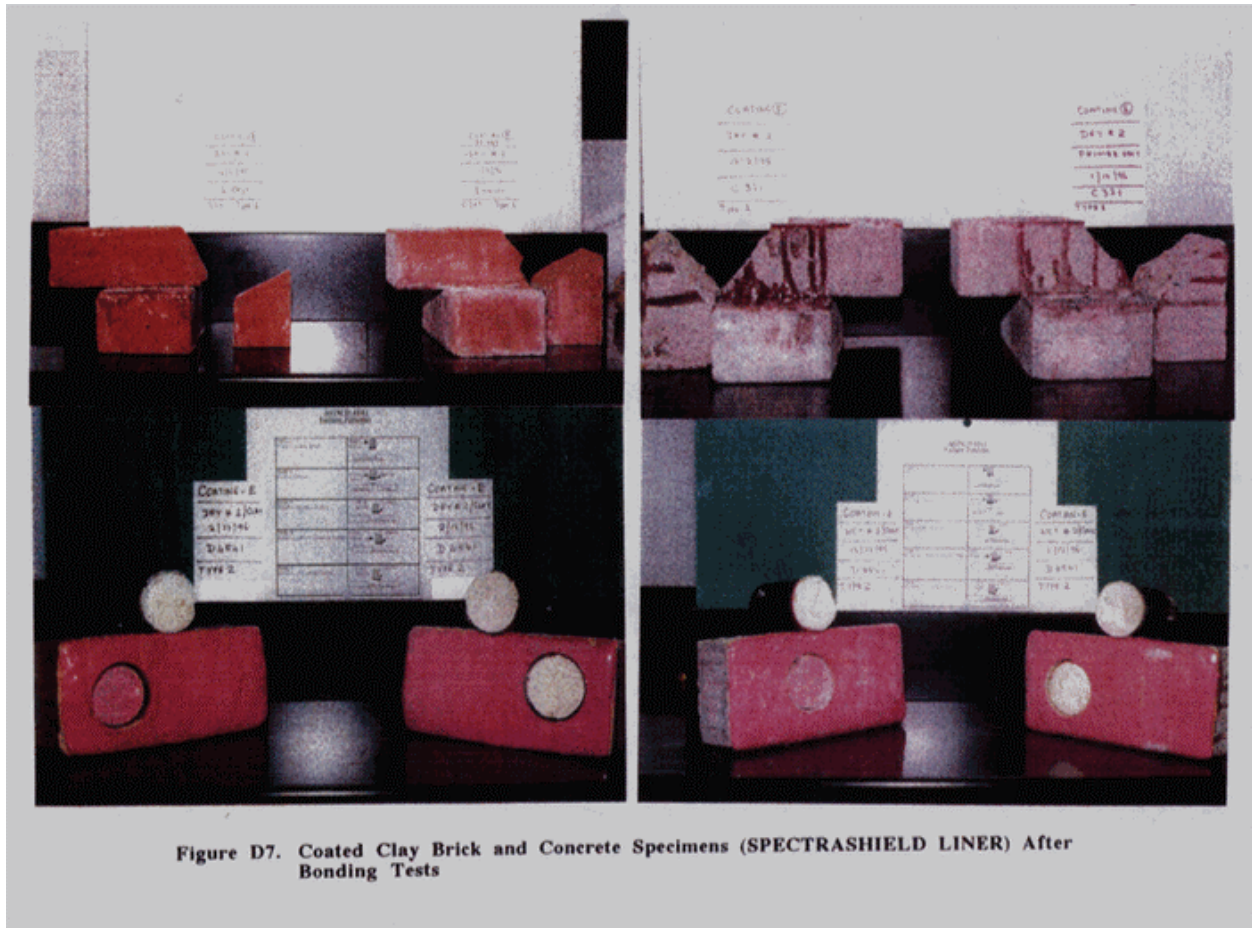

Figure D6. Bonding Strength of SPECTRASHIELD LINER with Clay Brick and Types of Failures During ASTM C321-94 Tests (a) Dry and (b) Wet Clay Bricks



APPENDIX: E

Miscellaneous

(1) Manufacturer's Data Sheets

(2) Other information from the Manufacturer

CITY OF HOUSTON

PHYSICAL PROPERTIES OF COATINGS FOR REINFORCED CONCRETE PIPES

Coating Product Name:

Coating Product Manufacturer Name and Address:

Coating Type:

PERFORMANCE CHARACTERISTICS - TEST AND METHOD	RESULT
Tensile Adhesion To Concrete (ASTM D 4541).	CONCRETE FAILURE 800 PSI ON STEEL psi.
Chemical Resistance (ASTM D 543) (20% NaOH @ 120° F, 10% H ₂ SO ₄ @ 120° F).	DNA % weight change. REFER TO ATTACHED SHEET
Water Vapor Transmission (Permeability) (ASTM D 1653).	E 96 perms. 30 DAY 0.03
Resistance To Cracking Flexibility (ASTM D 522).	638 110 % elongation.
Abrasion Resistance (ASTM D 4060).	0.3 grams loss/1000 cycles.
Hardness - Shore "D" (ASTM D 2240).	60 Shore "D" units.
Impact Resistance (ASTM G 14).	DNA in lbs.
Volatile Organic Compounds - VOC's (ASTM D 2832).	0 %.

WORKER SAFETY CHARACTERISTICS	RESULT / REQUIREMENT
Flammability Rating.	flammable / non-flammable.
Known Carcinogenic Compounds Content.	yes / no (include MSDS).
Coal Tar Content (w/w).	0 %.

ENVIRONMENT CHARACTERISTICS	RESULT / REQUIREMENT
Heavy Metal Content (w/w).	<u>NONE</u> provide list.
Leaching Of Cured Coating (EPA Methods # 624, 625 - TCLP)	<u>leaching/ non-leaching.</u>
Disposal Method For Cured Coatings.	<u>NON-HAZARDOUS PLASTIC</u> provide method statement.

APPLICATION CHARACTERISTICS	RESULT / REQUIREMENT
Primer Requirements.	<u>WE HAVE PROPRIETARY PRIMER FORMULATION THAT ENSURES OUR BOND & WILL CURE</u> include details. UNDER WATER.
# Of Coats Required To Apply Recommended DFT.	THERE ARE include details. FOUR LAYERS IN OUR COMPLETED SYSTEM
Minimum Application Temperature.	-25 °F.
Minimum Cure Time Before Handling.	30 SECONDS hours.
Maximum Application Temperature.	350 °F.
Minimum Cure Time Before Immersion Service.	30 MINUTES hours / days.
Coating Surface Preparation Required.	yes / no.

VENDOR QUALIFICATIONS	RESULT / REQUIREMENT
Length Of Time In Coatings MANUFACTURING Business.	22 years.
Approved Applicator Training & Qualification Program.	include details.
QA/QC Program - Coating Manufacturer.	include details.
Recommended QA/QC - Coatings Application	include details.
In-House R&D Facilities.	yes NO
In-House Coating Manufacturing.	yes / no.

Please add-in any additional properties using the same tabular format on a separate sheet.

SURVEY RESPONSE / QUESTIONNAIRE

Response Date: JUNE 26, 1995

Individual Contact Name and Address: KATHLEEN HUME
CCI SPECTRUM
6525 GREENLAND ROAD
JACKSONVILLE, FLORIDA 32258

Coating Product Name: SPECTRASHIELD LINER SYSTEM

Coating Product Manufacturer Name and Address:
NA

Coating Type: STRESS SKIN PANEL SYSTEM COMPOSED OF SPECIALIZED EPOXY PRIMER
AROMATIC POLYUREA
CLOSED CELL POLYUREATHANE FOAM

Q1. Would you be interested in participating in this testing program? Yes or No?

Q2. If no, why? Please comment.

Q3. Additional sheets may be attached should you have other questions or comments you would like to discuss.

I, JAMES MERRILL HUME, of CCI SPECTRUM
Type or print company official's name Type or print coating company's name

certify that the above information supplied for the product, SPECTRASHIELD LINER SYSTEM
Type or print product name or code

is correct:

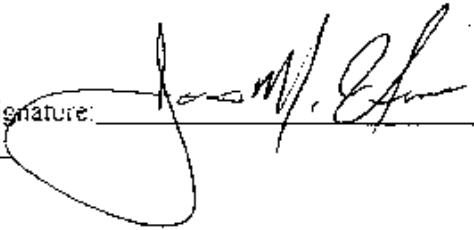
Signature: 

Date: JUNE 26, 1995

Company Seal or Rubber Stamp:

SURVEY RESPONSE/QUESTIONNAIRE

Response Date:

Individual Contact **Name and Address:**

Kathleen Hume

CCI Spectrum

6525 Greenland Road

Jacksonville, FL 32258

Coating Product Name: SPECTRASHIELD LINER SYSTEM

Coating Product Manufacturer Name and Address:

NA

Coating Type: STRESS SKIN PANEL SYSTEM COMPOSED OF SPECIALIZED EPOXY PRIMER

AROMATIC POLYUREA

CLOSED CELL POLYUREATHANE FOAM

Q1. Would you be interested in participating in this testing program? Yes or No

Q2. If no, why? Please comment.

Q3. Additional sheets may be attached should you have other questions or comments you would

like to discuss.

CONCRETE CONSERVATION, INC.

P O BOX 24354

Jacksonville, FL 32241

FIVE YEAR LIMITED WARRANTY

Concrete Conservation, Inc. warrants its repairs and **SPECTRASHIELD** coating against failure for a period of 5 years. "Failure" will be deemed to have occurred if the protective coating fails to (a) prevent the internal damage or corrosion of the structure or (b) protect the substrate and environment from contamination by effluent. If any such failure occurs within 5 years of initial completion of work by Concrete Conservation, Inc. on a structure, Concrete Conservation, Inc. will repair the damage and restore the coating at no cost to the Owner within 60 days after written notification of the failure. "Failure" does not include damage resulting from mechanical or chemical abuse or by an act of GOD. Mechanical or chemical abuse means exposing the coated surfaces of the structure to any mechanical force or chemical substance not customarily present or used in connection with structures of the type involved.

WARRANTY DISCLAIMER:

Concrete Conservation, Inc. makes no warranties express or implied other than those specifically stated in the Five Year Limited Warranty.

LIMITATION OF LIABILITY:

Any liability for consequential and incidental damages is expressly disclaimed. Concrete Conservation, Inc.'s liability in all events is limited to, and shall not exceed, the purchase price paid.

PHONE: (904) 268-4951

(800) 284-2030

FAX: (904) 268-4923